

TOP DEAL

KSTOOLS

WWW.KSTOOLS.COM

No Limits!

UNSERE SCHLÜSSELKOMPETENZ:

QUALITÄT ZUM HAMMER-PREIS!

EVOLUTION
SERIES



Komplette
Stückliste

917.0255

1/4" + 3/8" + 1/2" + 5/16"

255 TEILE
FÜR NUR

119,90

i 397
Weitere Informationen

P₁₀

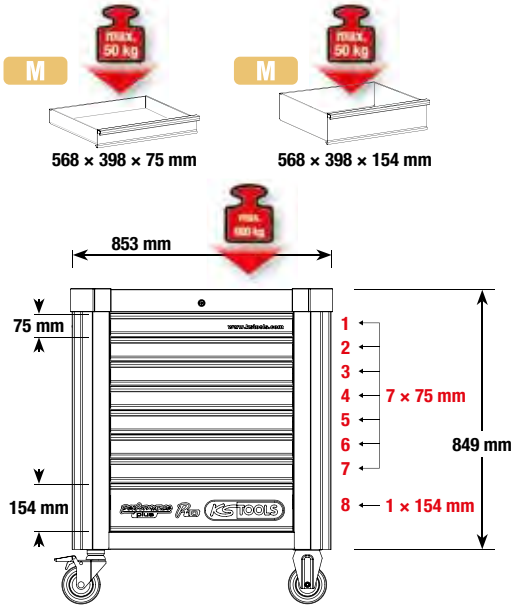

WÄHLEN SIE IHR POWER-PAKET

810.7397

i 397
Weitere Informationen

Options for the power package:

- inklusive Papierrollenhalter
- inklusive Dosenhalter
- Stabile Kugellager
- Antistatische Rollen mit Bremse
- OPTION 1 0

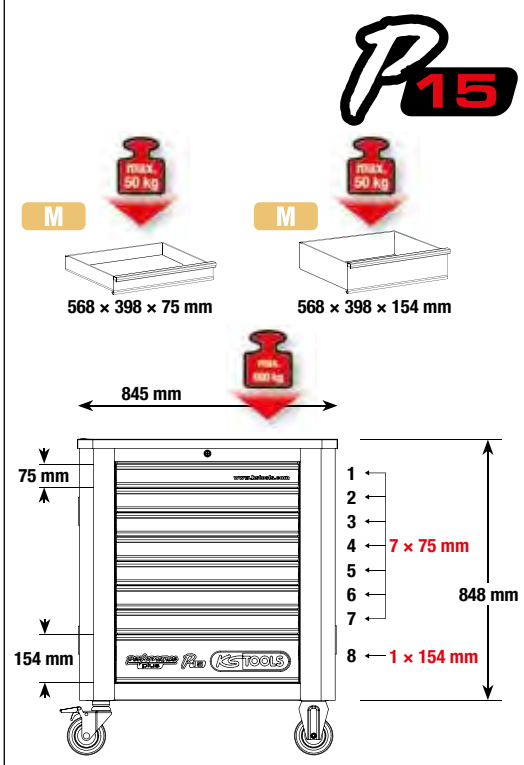

815.7397

DAS PERFEKTE PAKET MIT 397 TEILEN

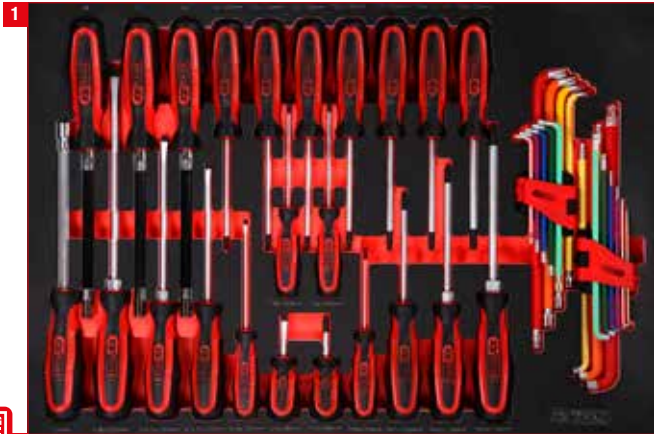

41 Schraubendreher-Satz



41 Schraubenschlüssel-Satz

2699,00

810.7397 P10 Werkstattwagen mit 397 Werkzeugen



111 1/4" + 3/8" + 1/2" Steckschlüssel-Satz

2799,00

815.7397 P15 Werkstattwagen mit 397 Werkzeugen



28 Zangen- und Feilen-Satz



43 Öl- und Reifendienst-Satz



111 1/2" Bit-Stecknuss-Satz



22 Hammer- und Meißel-Satz

HERZLICH WILLKOMMEN IN

i **564**
 Weitere Informationen



3799,00



Integrierter Kantenschutz



inklusive Dosenhalter



Stabile Kugellager



Antistatische Rollen mit Bremse



Schloss

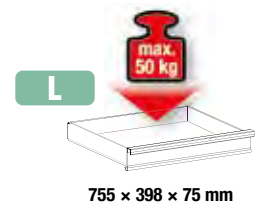
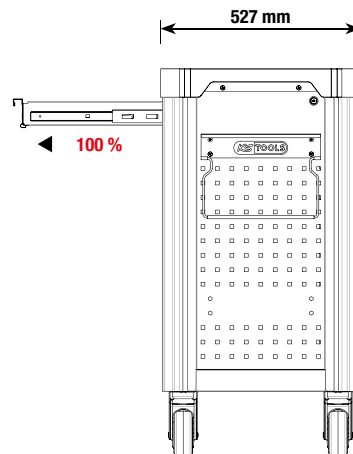
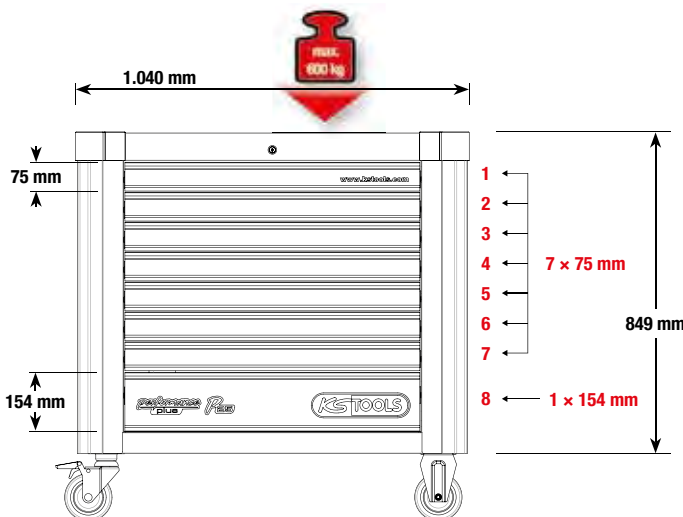

825.8564

DER KÖNIGSKLASSE!

Performance
plus

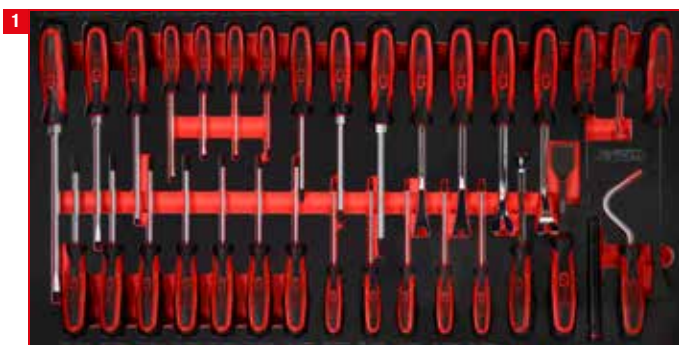

Schraubendreher-Satz

33



1/4\"/>

213



1/2\"/>

86

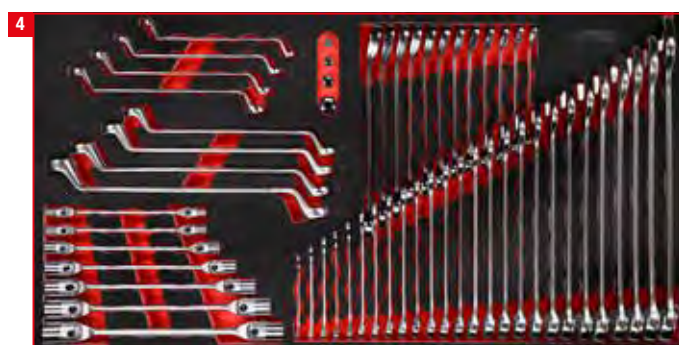

Schraubenschlüssel-Satz

57



Schraubenschlüssel-Satz

54

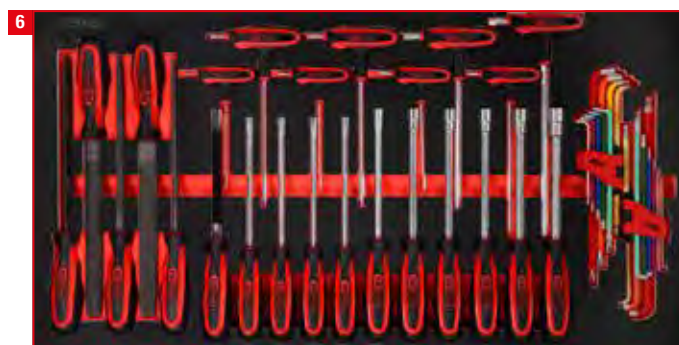

Schraubendreher- und Feilen-Satz

42

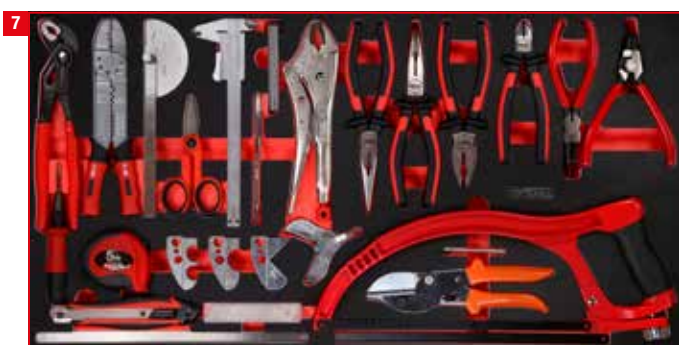

Zangen- und Messwerkzeug-Satz

39



Hammer- Meißel- und Kraft-Stecknuss-Satz

40

WIE VIEL WAGEN DARF'S SEIN?



Arbeitsplatte mit 10 mm starker Schaumstoffeinlage



verschießbar durch eingebautes Zylinderschloss



mit Selbsteinzug und SOFT-CLOSE-Funktion



Vierkantlochung für Zubehörteile



2 x Roll- und Drehbremsen Ø Räder: 125 mm

ECO Line

449,90

OHNE WERKZEUGE



i **1** 897.0007
Weitere Informationen

| Technische Daten: | Eco Line 897.0007 | Racing Line 826.0007 |
|--|-------------------|----------------------|
| Gesamtragkraft: | 300,0 kg | 350,0 kg |
| Belastbarkeit je Schublade: | 25,0 kg | 30,0 kg |
| Selbsteinzug und SOFT-CLOSE-Funktion: | ✓ | ✗ |
| Raddurchmesser: | 125,0 mm | 125,0 mm |
| Radfeststeller: | ✓ | ✓ |
| Mit Zentralverriegelung: | ✓ | ✓ |
| Einzelverriegelung Schubladen: | ✗ | ✓ |
| Höhe: | 1014,0 mm | 976,0 mm |
| Breite: | 748 mm | 788 mm |
| Tiefe: | 459,0 mm | 496,0 mm |
| Schubladeninnenmaß: | 565 x 395 mm | 565 x 395 mm |
| mit Polyurethan Ecken-Kantenschutz: | ✗ | ✓ |
| Vierkantlochung für Zubehörteile: | ✓ | ✓ |
| Anzahl Schubladen: | 7 | 7 |
| Blechstärke: | 0,8 mm | 0,9 mm |
| Griffeisten: | ✓ | ✓ |
| Schubladenauszug: | 100 % | 90 % |
| Arbeitsplatte mit Kleinteilfächern: | ✗ | ✓ |
| Arbeitsplatte mit Schaumstoffeinlagen: | ✓ | ✗ |
| kugellagerte Schubladenföhrung: | ✓ | ✓ |
| seitlicher Metallhandgriff: | ✓ | ✓ |

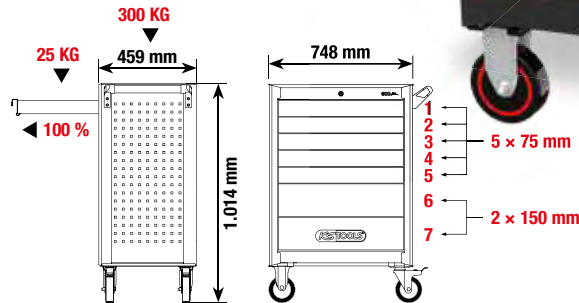

QUAL DER WAHL? WAHL MIT QUALITÄT!

RACING Line



Arbeitsplatte aus ABS mit Kleinteilfächern



verschießbar durch eingebautes Zylinderschloss



Einzelverriegelung verhindert ungewolltes Öffnen



Vierkantlochung für Zubehörteile



2 x Roll- und Drehbremsen Ø Räder: 125 mm

499,90

OHNE WERKZEUGE



i **1** 826.0007
Weitere Informationen

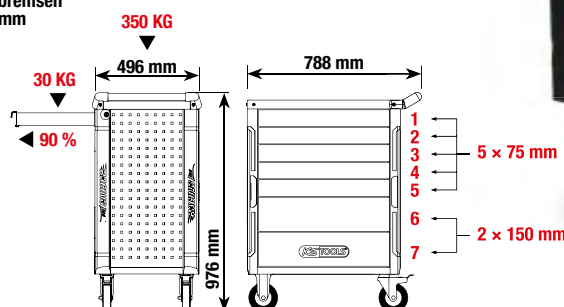

ECO *line*

Mit 7 Schubladen und
215 Premium-Werkzeugen

679,90

897.7215



START PAKET - 215 TLG.



RACING *line*

Mit 7 Schubladen und
215 Premium-Werkzeugen

699,90

826.7215

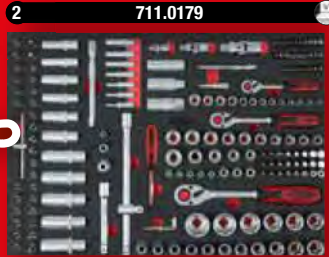

Weitere Informationen

ECO *line*

Mit 7 Schubladen und
515 Premium-Werkzeugen

879,90

897.7515



UNIVERSAL PAKET - 515 TLG.

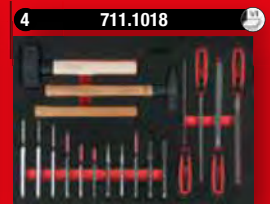

RACING *line*

Mit 7 Schubladen und
515 Premium-Werkzeugen

899,90

826.7515

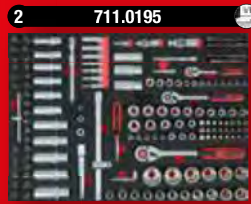

Weitere Informationen

ECO *line*

Mit 7 Schubladen und
598 Premium-Werkzeugen

1299,00

897.7598

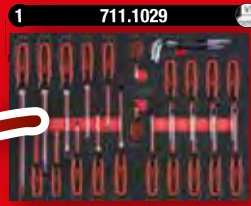

POWER PAKET - 598 TLG.



RACING *line*

Mit 7 Schubladen und
598 Premium-Werkzeugen

1349,00

826.7598

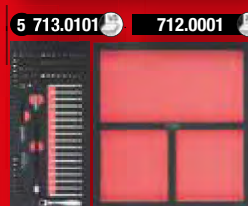
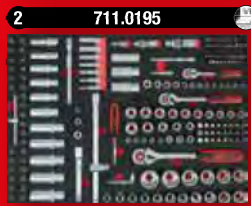

Weitere Informationen

- DIN 3110 / ISO 1085 / ISO 10102 / ISO 3318
- Maulstellung 15° abgewinkelt
- geschliffene Köpfe
- matt satiniert
- Chrom Vanadium

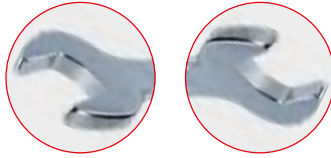

ab 19,90

| | | | | | |
|----------|----------|--|--|---|---------|
| A | 517.0148 | | | 6x7 · 8x9 · 10x11 · 12x13 14x15 · 16x17 · 18x19 20x22 mm | 19,90 € |
| B | 517.0123 | | | 6x7 · 8x9 · 10x11 · 12x13 14x15 · 16x17 · 18x19 20x22 · 21x23 · 24x27 30x32 mm | 44,90 € |
| C | 517.0125 | | | 6x7 · 8x9 · 10x11 · 12x13 14x15 · 16x17 · 18x19 20x22 · 21x23 · 24x27 25x28 · 30x32 mm | 49,90 € |



- FlankTraction-Profil
- Maulstellung 15° abgewinkelt
- Ring 15° abgewinkelt
- polierte Köpfe
- matt satiniert



ab 22,90

| | | | | | |
|----------|----------|--|--|--|----------|
| A | 517.0048 | | | 8 · 9 · 10 · 11 · 13 · 14 17 · 19 mm | 22,90 € |
| B | 517.0052 | | | 8 · 9 · 10 · 11 · 12 · 13 · 14 15 · 16 · 17 · 18 · 19 mm | 42,90 € |
| C | 517.0043 | | | 6 · 7 · 8 · 9 · 10 · 11 · 12 13 · 14 · 15 · 16 · 17 · 18 19 · 20 · 21 · 22 · 24 · 27 30 · 32 mm | 109,50 € |



- 12-kant
- DIN 838 / ISO 1085 / ISO 10104 / ISO 3318
- Ringe 75° gekröpft
- dünnwandig
- polierte Köpfe



ab 24,90

| | | | | | |
|----------|----------|--|--|---|---------|
| A | 517.0248 | | | 6x7 · 8x9 · 10x11 · 12x13 14x15 · 16x17 · 18x19 20x22 mm | 24,90 € |
| B | 517.0222 | | | 6x7 · 8x9 · 10x11 · 12x13 14x15 · 16x17 · 18x19 20x22 · 21x23 · 24x27 30x32 mm | 49,90 € |



i **1**
Weitere Informationen

14,90

315 mm

22 mm

19 mm

522.1922

i **1**
Weitere Informationen

DIE 4 IN 1 WENDERATSCHKE

10 mm

13 mm

17 mm

19 mm

19,90

72°

5°

503.4565

10 x 13 x 17 x 19 mm

i **1**
Weitere Informationen

DAS MULTITALENT

Einhand-Multifunktions-Schlüssel

260 mm

8-17 mm

14-32 mm

114.0055

8 · 9 · 10 · 11 · 12 · 13 · 14 · 15 · 16 · 17 · 18 · 19 · 20 · 21 · 22 · 23 · 24 · 25 · 26 · 27 · 28 · 29 · 30 · 31 · 32 mm

33,90

i **12**
Weitere Informationen

72°

5°

119,90

503.4665

8 · 9 · 10 · 11 · 12 · 13 · 14 · 15 · 16 · 17 · 18 · 19 mm

i **30**
Weitere Informationen

DER ALLESKÖNNER

5/16" x 13 mm

1/2"

10 mm x 13 mm

3/8"

1/4" x 10 mm

1/4"

12 x

12 x

168,90

503.4960

8 · 9 · 10 · 11 · 12 · 13 · 14 · 15 · 16 · 17 · 18 · 19 mm

i **2**
Weitere Informationen

72 5°

1/2" 305 - 445 mm

1/4" 173 - 223 mm

VERSTELLBAR:
1/4" IN 4 STUFEN
1/2" IN 6 STUFEN

NEU **34,90**

914.1412

i **1**
Weitere Informationen

NEU 600 MM!

72 5°

1/2" 460 - 600 mm

Stufe: 1 2 3 4 5 6

24,90

VERSTELLBAR IN 6 STUFEN

914.1205

i **1**
Weitere Informationen

49,90

760 mm

**MAXIMALE FLEXIBILITÄT,
OPTIMALE KONTROLLE**

1/2"

918.1293

72 5°

**BESTÄNDIGE POWER –
INNOVATIVE FUNKTION**

A B C

1/4" 3/8" 1/2"

ab 24,90

| | | | Nm | | | |
|----------|----------|--|------|-----|--------|---------|
| A | 920.1490 | | 1/4" | 102 | 140 mm | 24,90 € |
| B | 920.3890 | | 3/8" | 325 | 190 mm | 29,90 € |
| C | 920.1290 | | 1/2" | 710 | 245 mm | 36,50 € |

102 Nm

710 Nm

72 5°

54,90

920.0002 **i** **2**
Weitere Informationen

DIE BESTEN, DIE WIR JE GEBAUT HABEN!

Wir wissen, was wir können. Und weil wir ganz genau wissen, wie gut unser neues Monster-Ratschen-Sortiment ist, ist es für uns selbstverständlich, Ihnen eine Garantie auf jedes Modell zu gewähren. Nicht 2 oder 3 Jahre. Nein, es sind gleich 10 Jahre! Damit die Garantie genauso Premium ist wie unsere Monster-Ratschen!



1 **80°** **29,90** **1/4"** **1**
 Weitere Informationen

935.1490 **1/4"** **106 g** **125 mm** **>110 Nm**



2 **80°** **29,90** **1/4"** **1**
 Weitere Informationen

935.1495 **1/4"** **106 g** **125 mm** **>100 Nm**

3 **96°** **39,90** **3/8"** **1**
 Weitere Informationen

935.3890 **3/8"** **227 g** **199 mm** **>365 Nm**



**GARANTIERT:
6 MONSTER
FÜRS LEBEN!**

4 **100°** **49,90** **1/2"** **1**
 Weitere Informationen

935.1290 **1/2"** **567 g** **275 mm** **>950 Nm**

5 **100°** **69,90** **1/2"** **1**
 Weitere Informationen

935.1295 **1/2"** **757 g** **425 mm** **>950 Nm**

6 **100°** **99,90** **1/2"** **1**
 Weitere Informationen

TELESKOPIERBAR

406 431 457 482 508 533 557 582 607 635 mm **>950 Nm**

935.1285 **1/2"** **1.280 g** **406 - 635 mm**

NEU **-15%** **100°** **1/2"** **>950 Nm** **+** **80°** **1/4"** **>110 Nm** **1**
 Weitere Informationen

935.0002 **69,90**

Alle Preise in EUR zzgl. MwSt. gelten bis 30.09.2024



9

Bit-Stecknuss-Satz für Innensechskant-Schrauben, kurz

3/8"

4 mm 5 mm 6 mm 7 mm 8 mm 9 mm 10 mm 12 mm 14 mm

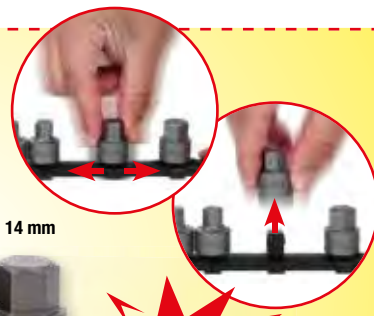

NEU

34,90

917.4000 4 - 5 - 6 - 7 - 8 - 9 - 10 - 12 - 14 mm

BITTE EIN BIT. ABER KURZ!



10

Bit-Stecknuss-Satz für Torx-Schrauben, kurz

3/8"

T10 T15 T20 T25 T27 T30 T40 T45 T50 T55

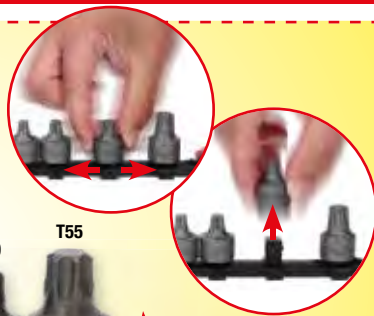

NEU

39,90

917.4015 T10 - T15 - T20 - T25 - T27 - T30 - T40 - T45 - T50 - T55

TORX TOTAL: ALLES IN EINEM KOFFER



77

Weitere Informationen

| | | |
|-----|--|--|
| 5 x | | 1/4": E4 - E5 - E6 - E7 - E8 |
| 4 x | | 3/8": E10 - E12 - E14 - E16 |
| 4 x | | 1/2": E18 - E20 - E22 - E24 |
| 5 x | | 1/4": EPL4 - EPL5 - EPL6 - EPL7 - EPL8 |
| 4 x | | 3/8": EPL10 - EPL12 - EPL14 - EPL16 |
| 4 x | | 1/2": EPL18 - EPL20 - EPL22 - EPL24 |
| 8 x | | 1/4": T6 - T8 - T10 - T15 - T20 - T25 - T27 - T30 |
| 5 x | | 3/8": T40 - T45 - T47 - T50 - T55 |
| 2 x | | 1/2": T60 - T70 |
| 7 x | | 1/4": TB8 - TB10 - TB15 - TB20 - TB25 - TB27 - TB30 |
| 4 x | | 3/8": TB40 - TB45 - T50 - T55 |
| 1 x | | 1/2": TB60 |
| 7 x | | 1/4": IP8 - IP10 - IP15 - IP20 - IP25 - IP27 - IP30 |
| 3 x | | 3/8": IP40 - IP45 - IP50 |
| 2 x | | 1/2": IP55 - IP60 |
| 7 x | | 1/4": IPR8 - IPR10 - IPR15 - IPR20 - IPR25 - IPR27 - IPR30 |
| 3 x | | 3/8": IPR40 - IPR45 - IPR50 |
| 2 x | | 1/2": IPR55 - IPR60 |

- E ✓
- EPL ✓
- TX ✓
- TB ✓
- IP ✓
- IPR ✓

99,90

NEU



EVOLUTION SERIES

1/4" + 3/8" + 1/2"



911.0077

i **30**
Weitere Informationen

EVOLUTION SERIES

NEU

79,90

1/2"

911.4510

| | | |
|--------|--|---|
| 55 mm | | 5 - 6 - 7 - 8 - 10 - 12 - 14 - 17 - 19 mm |
| 100 mm | | 5 - 6 - 7 - 8 - 10 - 11 - 12 - 13 mm |
| 140 mm | | 5 - 6 - 7 - 8 - 10 - 12 - 14 mm |
| 200 mm | | 5 - 6 - 7 - 8 - 10 - 12 mm |

STAINLESS STEEL

i **32**
Weitere Informationen

EVOLUTION SERIES

NEU

79,90

1/2"

911.4520

| | | |
|--------|--|--|
| 55 mm | | M5 - M6 - M7 - M8 - M9 - M10 - M12 - M13 - M14 |
| 100 mm | | M5 - M6 - M7 - M8 - M9 - M10 - M12 - M13 - M14 |
| 140 mm | | M7 - M8 - M9 - M10 - M12 - M13 - M14 |
| 200 mm | | M7 - M8 - M9 - M10 - M12 - M13 - M14 |

STAINLESS STEEL

i **26**
Weitere Informationen

EVOLUTION SERIES

NEU

79,90

1/2"

911.4540

| | | |
|--------|--|---|
| 55 mm | | M5 - M6 - M8 - M9 - M10 - M12 - M14 - M16 |
| 100 mm | | M5 - M6 - M8 - M9 - M10 - M12 - M14 |
| 140 mm | | M5 - M6 - M8 - M9 - M10 - M12 - M14 |
| 200 mm | | M8 - M10 - M12 - M14 |

STAINLESS STEEL

i **32**
Weitere Informationen

EVOLUTION SERIES

NEU

79,90

1/2"

911.4550

| | | |
|--------|--|---|
| 55 mm | | T20 - T25 - T27 - T30 - T40 - T45 - T50 - T55 - T60 - T70 |
| 100 mm | | T20 - T25 - T27 - T30 - T40 - T45 - T50 - T55 - T60 - T70 |
| 140 mm | | T40 - T45 - T50 - T55 - T60 - T70 |
| 200 mm | | T40 - T45 - T50 - T55 - T60 - T70 |

STAINLESS STEEL

A matt satiniert **B** hochglanz verchromt

ab 27,90

vernickelt

| | | | | | | |
|----------|----------|--|----|---------|------|---|
| A | 917.0648 | | 48 | 27,90 € | 1/4" | |
| B | 918.0648 | | 48 | 29,90 € | | 4- 4,5 - 5 - 5,5 - 6 - 7 - 8 - 9 10 - 11 - 12 - 13 - 14 mm |

A matt satiniert

59,90

vernickelt

| | | | | | | |
|----------|----------|--|----|---------|------|---|
| A | 911.0620 | | 20 | 59,90 € | 1/2" | |
| | | | | | | 10 - 11 - 12 - 13 - 14 - 15 16 - 17 - 18 - 19 - 22 - 24 27 - 30 - 32 mm |

A matt satiniert **B** hochglanz verchromt

ab 79,90

vernickelt

| | | | | | | |
|----------|----------|--|----|---------|-------------|--|
| A | 911.0694 | | 94 | 79,90 € | 1/4" + 1/2" | |
| B | 918.0694 | | 94 | 89,90 € | | 4- 4,5 - 5 - 5,5 - 6 - 7 - 8 - 9 10 - 11 - 12 - 13 - 14 - 15 - 16 17 - 18 - 19 - 20 - 21 - 22 - 23 24 - 27 - 30 - 32 mm |

A matt satiniert

89,90

vernickelt

| | | | | | | |
|----------|----------|--|-----|---------|-------------|---|
| A | 911.0708 | | 108 | 89,90 € | 1/4" + 1/2" | |
| | | | | | | 4- 4,5 - 5 - 5,5 - 6 - 7 - 8 - 9 10 - 11 - 12 - 13 - 14 - 15 - 16 17 - 18 - 19 - 20 - 21 - 22 - 24 27 - 30 - 32 mm |



Weitere Informationen

| | |
|---------------------|---|
| 1/4" | <ul style="list-style-type: none"> 4 - 4,5 - 5 - 5,5 - 6 - 7 - 8 - 9 - 10 - 11 - 12 - 13 - 14 mm 4 - 5 - 6 - 7 - 8 - 9 - 10 mm E4 - E5 - E6 - E7 - E8 |
| 3/8" | <ul style="list-style-type: none"> 10 - 11 - 12 - 13 - 14 - 15 - 16 - 17 - 18 - 19 mm 10 - 11 - 12 - 13 - 14 - 15 mm E10 - E11 - E12 - E14 - E16 - E1 |
| 1/2" | <ul style="list-style-type: none"> 10 - 11 - 12 - 13 - 14 - 15 - 16 - 17 - 18 - 19 - 20 - 21 - 22 - 24 - 27 - 30 - 32 mm 16 - 17 - 18 - 19 - 22 mm E20 - E24 |
| 1/4" 5/16" | <ul style="list-style-type: none"> 10 - 11 - 12 - 13 - 14 - 15 - 16 - 17 - 18 - 19 - 20 - 21 - 22 - 24 - 27 - 30 - 32 mm 1,3 - 1,5 - 2 - 2,5 - 3 - 4 - 5 mm |
| 1/4" - 3/8" 1/2" | <ul style="list-style-type: none"> 50 - 100 - 125 - 150 - 250 mm 1,3 - 1,5 - 2 - 2,5 - 3 - 4 - 5 mm |
| 1/4" - 3/8" 1/2" | <ul style="list-style-type: none"> 1/4" - 5/16" |
| 1/4" | |

1/4" + 3/8" + 1/2"

vernickselt

matt satiniert



94,90

| | |
|---------------------|---|
| 1/4" | <ul style="list-style-type: none"> 4 - 4,5 - 5 - 5,5 - 6 - 7 - 8 - 9 - 10 - 11 - 12 - 13 - 14 mm 6 - 7 - 8 - 9 - 10 - 11 - 12 - 13 - 14 - 15 mm |
| 3/8" | <ul style="list-style-type: none"> 10 - 11 - 12 - 13 - 14 - 15 - 16 - 17 - 18 - 19 mm 10 - 11 - 12 - 13 - 14 - 15 mm |
| 1/2" | <ul style="list-style-type: none"> 10 - 11 - 12 - 13 - 14 - 15 - 17 - 18 - 19 - 20 - 21 - 22 - 24 - 27 - 30 - 32 mm 17 - 19 - 22 mm |
| 1/4" 5/16" | <ul style="list-style-type: none"> 8 - 9 - 10 - 11 - 12 - 13 - 14 - 15 - 16 - 17 - 18 - 19 mm 1,3 - 1,5 - 2 - 2,5 - 3 - 4 - 5 mm |
| 12 x | <ul style="list-style-type: none"> 8 - 9 - 10 - 11 - 12 - 13 - 14 - 15 - 16 - 17 - 18 - 19 mm 1,3 - 1,5 - 2 - 2,5 - 3 - 4 - 5 mm |
| 1/4" - 3/8" 1/2" | |
| 1/4" | |



ab 174,90

A matt satiniert

B hochglanz verchromt

A 917.0216 216 174,90 €

B 918.0216 216 189,90 €

1/4" + 3/8" + 1/2"



| | | | | | | | |
|----------|----------|--|--|----|--|--|----------------------|
| A | 911.0721 | | | 21 | | 19 · 21 · 22 · 23 · 24 · 26 · 27 · 29 · 30 32 · 35 · 36 · 38 · 41 · 46 · 50 mm | 219, ⁹⁰ € |
| B | 911.0722 | | | 21 | | 19 · 21 · 22 · 23 · 24 · 26 · 27 · 29 · 30 32 · 35 · 36 · 38 · 41 · 46 · 50 mm | 248, ⁵⁰ € |
| C | 911.0751 | | | 21 | | 3/4" · 13/16" · 7/8" · 15/16" · 1" 1.1/16" · 1.1/8" · 1.3/16" · 1.1/4" 1.5/16" · 1.3/8" · 1.7/16" · 1.1/2" 1.5/8" · 1.3/4" · 2" | 248, ⁵⁰ € |

ab
219,⁹⁰

| | | | |
|------------------------------|--|--|--|
| | | | 82 |
| Weitere Informationen | | | |
| 1/4" | | | 4 - 4,5 - 5 - 5,5 - 6 - 7 - 8 - 9 - 10 - 11 12 - 13 - 14 mm |
| 1/2" | | | 14 - 15 - 16 - 17 - 18 - 19 - 20 - 21 - 22 24 - 27 - 30 - 32 mm |
| 1/4" | | | 16 - 21 mm |
| 1/4" | | | |
| 5/16" | | | |
| 1/4" | | | |
| 1/2" | | | |
| 1/4" | | | 150 mm |
| 1/4" | | | 50 - 100 - 125 - 250 mm |
| 1/2" | | | |
| 1/4" | | | 150 mm |
| 12 x | | | 8 - 10 - 11 - 12 - 13 - 14 - 17 - 19 - 22 mm |



129,⁹⁰

911.0682 **1/4" + 1/2"**

i  **47**
 Weitere Informationen













| | | |
|------|--|---|
| 1/2" |  | 10 - 11 - 12 - 13 - 14 - 15 - 16 - 17 18 - 19 - 20 - 21 - 22 - 24 mm |
| 3 x |  | 16 - 18 - 21 mm |
| 14 x |  | 6 - 7 - 8 - 9 - 10 - 11 - 12 - 13 - 14 15 - 16 - 17 - 18 - 19 mm |
| 1 x |  | 250 mm |
| 2 x |  | 125 - 250 mm |
| 1 x |  | 1/2" |
| 5 x |  | 3 - 5,5 - 8 mm + PH1 - PH2 |
| 1 x |  | T8 - T10 - T15 - T20 - T25 - T27 T30 - T40 |
| 1 x |  | 2,5 - 3 - 4 - 5 - 6 - 7 - 8 - 10 mm |
| 1 x |  | 3 - 48 V |
| 1 x |  | 240 mm |
| 1 x |  | 180 mm |
| 1 x |  | 300 g |



149,90

matt
satinert

1/2" 
 940.0047

| | | |
|------|---|---|
| 1/4" |  | 4 - 4,5 - 5 - 5,5 - 6 - 7 - 8 - 9 - 10 11 - 12 - 13 mm |
| 1/2" |  | 10 - 11 - 12 - 13 - 14 - 15 - 16 - 17 19 - 20 - 21 - 22 - 24 - 27 - 30 - 32 mm |
| 12 x |  | 8 - 9 - 10 - 11 - 12 - 13 - 14 - 15 - 16 17 - 18 - 19 mm |
| 2 x |  | 1/4": 100 mm / 1/2": 125 mm |
| 1 x |  | 1/4" / 1/2" |
| 7 x |  | 3 - 4 - 5,5 - 6,5 mm + PH0 - PH1 - PH2 |
| 1 x |  | T8 - T10 - T15 - T20 - T25 - T27 - T30 T40 - T45 - T50 |
| 1 x |  | 1,5 - 2 - 2,5 - 3 - 4 - 5 - 6 - 8 - 10 mm |
| 1 x |  | 300 g |
| 1 x |  | 160 mm |
| 1 x |  | 200 mm |



1/4" + 1/2" **A** matt satinert **B** hochglanz verchromt

| | | | |
|----------|--|--|----------|
| A | 917.0797  | 97  | 174,90 € |
| B | 918.0797  | 97  | 189,90 € |



ab **174,90**

i **88**
 Weitere Informationen

| | | |
|------|--|--|
| 1/4" | | 4 - 4,5 - 5 - 5,5 - 6 - 7 - 8 - 9 - 10 - 11 12 - 13 mm |
| 1/2" | | 14 - 15 - 16 - 17 - 18 - 19 - 20 - 21 - 22 23 - 24 - 25 - 26 - 27 - 28 30 - 32 mm |
| 12 x | | 6 - 7 - 8 - 9 - 10 - 11 - 12 - 13 - 14 17 - 19 - 22 mm |
| 3 x | | 1/4": 50 - 100 mm / 1/2": 125 mm |
| 1 x | | 1/4" |
| 4 x | | 6,5 - 8 mm PH1 - PH2 |
| 1 x | | 1/4" |
| 1 x | | 1/4" |
| 1 x | | 150 - 250 V |
| 1 x | | 250 mm |
| 1 x | | 180 mm |
| 1 x | | 300 g |

189,⁹⁰

matt satiniert

1/4" + 1/2"

911.0688

i **127**
 Weitere Informationen

DER ALLESKÖNNER

| | | |
|------|--|---|
| 4 x | | |
| 8 x | | 8 - 9 - 10 - 11 - 13 14 - 17 - 19 mm |
| 1/4" | | 4 - 4,5 - 5 - 5,5 - 6 - 7 8 - 9 - 10 - 11 - 12 13 - 14 mm |
| 1/2" | | 10 - 13 - 14 - 16 - 17 18 - 19 - 20 - 22 - 24 27 - 30 - 32 mm |

369,⁹⁰

1/4" + 1/2"

911.0727

Alle Preise in EUR zzgl. MwSt. gelten bis 30.09.2024



Weitere Informationen



| | | |
|------|--|--|
| 1/4" | | 4 - 4,5 - 5 - 5,5 - 6 - 7 8 - 9 - 10 - 11 - 12 13 mm |
| 1/2" | | 10 - 13 - 14 - 15 - 16 17 - 18 - 19 - 21 - 22 24 - 27 - 30 - 32 mm |
| 10 x | | 8 - 10 - 11 - 12 - 13 14 - 15 - 17 - 19 - 22 mm |



389,90

911.0649

1/4" + 1/2"

**VOLLAUSSTATTUNG?
DANN HIER ZUGREIFEN!**



Weitere Informationen



| | | |
|-----|--|--|
| 9 x | | 1,5 - 2 - 2,5 - 3 - 4 - 5 - 6 8 - 10 mm |
| 9 x | | TS10 - TS15 - TS20 - TS25 TS27 - TS30 - TS40 - TS45 TS50 |



| | | |
|------|--|---|
| 1/4" | | 4 - 4,5 - 5 - 5,5 - 6 - 7 8 - 9 - 10 - 11 - 12 13 mm |
| 1/2" | | 10 - 11 - 12 - 13 - 14 15 - 16 - 17 - 18 - 19 21 - 22 - 24 - 27 - 30 32 mm |
| 11 x | | 8 - 9 - 10 - 11 - 12 13 - 14 - 16 - 17 - 19 22 mm |



449,90

911.0630

1/4" + 1/2"



Weitere Informationen

FÜR ELEKTRIKER

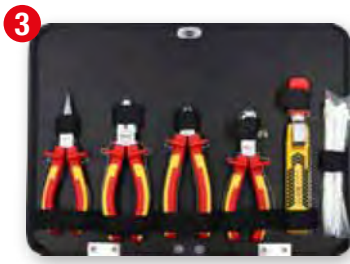

389,90

4 x

1/4" 4 - 4,5 - 5 - 5,5 - 6 - 7 - 8
9 - 10 - 11 - 12 - 13 mm

1/2" 10 - 11 - 12 - 13 - 14 - 15
16 - 17 - 18 - 19 - 21 - 22 mm

10 x 8 - 10 - 11 - 12 - 13 - 14
15 - 17 - 19 - 22 mm

911.0628

1/4" + 1/2"



Weitere Informationen

DER ALLROUNDER

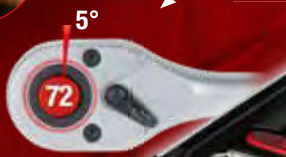
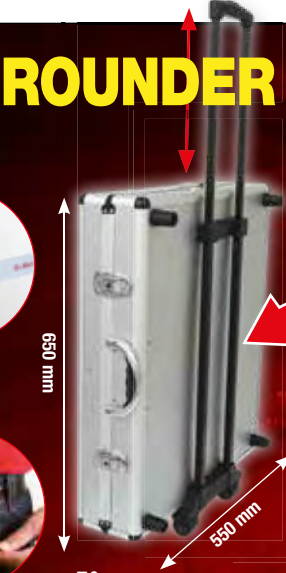

519,90

1/4" 4 - 5 - 6 - 7 - 8 - 9 - 11
12 - 13 mm

1/2" 10 - 11 - 12 - 13 - 14 - 15 - 16
17 - 18 - 19 - 21 - 22 - 24 mm

10 x 8 - 9 - 10 - 11 - 12 - 13
14 - 16 - 17 - 18 - 19 mm

911.0735

1/4" + 1/2"

DIE SCHATZTRUHEN!



Weitere Informationen



Weitere Informationen



RATSCHENRINGMAULSCHLÜSSEL

8 - 9 - 10 - 11 - 12 - 13 - 14 - 15 - 16 - 17 - 18 - 19 mm

| | |
|------|---|
| 1/4" | 4 - 5 - 6 - 7 - 8 - 9 - 10 - 11 - 12 13 - 14 mm |
| 1/2" | 13 - 15 - 17 - 18 - 19 - 20 - 21 - 22 24 - 27 - 30 - 32 mm |



RINGMAULSCHLÜSSEL

8 - 9 - 10 - 11 - 12 - 13 - 14 - 15 - 16 - 17 - 18 - 19 mm

SIE HABEN DIE WAHL!



599,90

1/4" 1/2"



519,90

1/4" 1/2"



918.0100

918.0200



Weitere Informationen



114,90

515.0065





Weitere Informationen





1





R
L



ab
99,90





Skala mit Lupe



Mikrometerskala

| | | Nm | Teilung Nm | Lbf-ft | | |
|----------|--|------|------------|--------|-----------|----------|
| 516.1402 | | 1/4" | 1-5 | 0,10 | 0,8 - 3,6 | 99,90 € |
| 516.1412 | | 1/4" | 5-25 | 0,10 | 0,8 - 18 | 99,90 € |
| 516.1422 | | 3/8" | 10-50 | 0,25 | 4 - 37 | 99,90 € |
| 516.1432 | | 1/2" | 20-100 | 0,50 | 8 - 75 | 110,90 € |
| 516.1442 | | 1/2" | 40-200 | 1,00 | 15 - 150 | 110,90 € |
| 516.1472 | | 1/2" | 60-320 | 1,00 | 45 - 236 | 124,90 € |
| 516.1482 | | 1/2" | 80-420 | 1,00 | 60 - 310 | 135,90 € |
| 516.1493 | | 3/4" | 150-750 | 10,00 | 150 - 550 | 588,90 € |
| 516.1495 | | 1" | 200-1000 | 20,00 | 220 - 730 | 673,90 € |

3 IN 1



1



2



3

LANG

9,90

| | | | | | | |
|---|----------|--|---|---|--|--------|
| A | 151.2100 | | 8 | ● | 2 - 2,5 - 3 - 4 - 5 - 6 8 - 10 mm | 9,90 € |
| B | 151.2300 | | 8 | ★ | T10 - T15 - T20 - T25 T30 - T40 - T45 - T50 | 9,90 € |



Weitere Informationen





22

LANG

12,90

DIE WICHTIGSTEN 22 IN EINEM SATZ

| | | | | | | | | | |
|----------|--|--|--|--|--|--|--|--|--|
| 151.4000 | | | | | | | | | |
|----------|--|--|--|--|--|--|--|--|--|

i **32**
Weitere Informationen

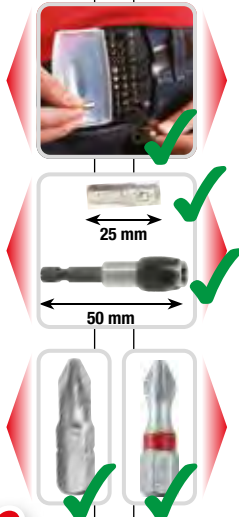

i **32**
Weitere Informationen

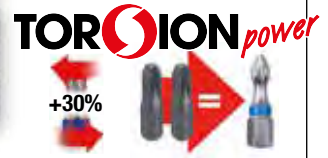

- 1 x 1/4"
- 1 x 1/4"
- 3 x PH1 - PH2 - PH3
- 6 x 2 x PZ1 - 2 x PZ2 - 2 x PZ3
- 3 x 5,5 - 6,5 - 8 mm
- 3 x 4 - 5 - 6 mm
- 15 x 2 x TB10 - 3 x TB15 - 2 x TB20
3 x TB25 - 3 x TB30 - 2 x TB40

911.2060

8,90

911.3030

9,90

- 1 x 1/4"
- 1 x 1/4"
- 4 x 3 - 4 - 5 - 6 mm
- 4 x PH1 - 2 x PH2 - PH3
- 4 x PZ1 - 2 x PZ2 - PZ3
- 4 x 3 - 4 - 5 - 6 mm
- 7 x T10 - T15 - T20 - T25 - T27 - T30 - T40
- 7 x TB10 - TB15 - TB20 - TB25 - TB27 - TB30 - TB40

i **108**
Weitere Informationen

TORION power

- 25 mm 6x: 4 - 5 - 6 mm
- 6x: 4 - 5 - 6 mm
- 6x: PH1 - PH2 - PH3
- 6x: PZ1 - PZ2 - PZ3
- 6x: T10 - T15 - T20 - T25 - T30 - T40

29,90



918.3108

1/4"

108 BITS, DIE DEN UNTERSCHIED MACHEN

i **32**
Weitere Informationen



- 4 x 3 - 4 - 5 - 6 mm
- 4 x PH1 - 2 x PH2 - PH3
- 4 x PZ1 - 2 x PZ2 - PZ3
- 4 x 3 - 4 - 5 - 6 mm
- 7 x T10 - T15 - T20 - T25
T27 - T30 - T40
- 7 x TB10 - TB15 - TB20 - TB25
TB27 - TB30 - TB40



44,90

918.3010

1/4"

i **31**
Weitere Informationen

TORION power



- 2 x 4 - 5 mm
- 3 x PH1 - PH2 - PH3
- 3 x PZ1 - PZ2 - PZ3
- 9 x 1,5 - 2 - 2,5 - 3 - 4 - 5 - 6
7 - 8 mm
- 11 x T6 - T7 - T8 - T9 - T10 - T15
T20 - T25 - T27 - T30 - T40

57,90

918.3015

1/4"

i **24**
 Weitere Informationen

KLEIN & FEIN

25 mm
 vernickelt

19,90

| | | |
|-----|--|----------------------------------|
| 1 x | | 1/4": 92 mm |
| 1 x | | 1/4": 50 mm |
| 1 x | | 1/4" |
| 6 x | | 6 - 7 - 8 - 10 - 11 - 13 mm |
| 2 x | | PH1 - PH2 |
| 2 x | | PZ1 - PZ2 |
| 2 x | | 4,5 - 5,5 mm |
| 4 x | | 3 - 4 - 5 - 6 mm |
| 5 x | | TB10 - TB15 - TB20 - TB25 - TB30 |

911.2010 **1/4"**

i **208**
 Weitere Informationen

39,90

DER ALLES-SCHRAUBER!

| | | |
|-------|--|--|
| 1/4" | | 1/4": 205 mm |
| 138 x | | 25 mm |
| 29 x | | 50 mm |
| 18 x | | 75 mm |
| 20 x | | 4 - 5 - 6 - 7 - 8 - 9 - 10 - 11 - 12 - 13 mm 5/32" - 3/16" - 7/32" - 1/4" - 9/32" 5/16" - 11/32" - 3/8" - 7/16" - 1/2" |
| 1 x | | 1/4": 50 mm |
| 1 x | | 1/4" |

911.2008 **1/4"**

i **7**
 Weitere Informationen

DAS KLEINE TECHNIKWUNDER!

9,90

6 IN ONE

- 4 - 5 mm
- PH1 - PH2
- PZ1 - PZ2

NEU

110 mm

1/4"

159.2025 **6 in 1 Mini-Ratschen-Schraubendreher**

i **13**
 Weitere Informationen

14,90

12 IN ONE

- 4 - 5 - 6 mm
- PH1 - PH2 - PH3
- 3 - 4 - 5 mm
- T15 - T20 - T25

240 mm

1/4"

159.2035 **12 in 1 Ratschen-Bit-Schraubendreher**

1
Weitere Informationen

2 IN 1

1/4"

85 mm

8,90

514.1126

ODER

1
Weitere Informationen

1/4"

10,90

MIT GELENK

90 mm

20°

514.1136

21
Weitere Informationen

4 mm

30 mm **165 mm**

Ø 16 mm

39,90

500.7195

1 - 1,3 - 1,5 - 2 - 2,5 - 3 mm

PH00 - PH0 - PH1 - PH2

1,5 - 2 - 2,5 - 3 - 3,5 mm

T3 - T4 - T5 - T6 - T7

Max USB

27
Weitere Informationen

LED

1/4"

eMONSTER

KSTOOLS

MAX

max 6 Nm

max 4 Nm

max 2 Nm

34,90

515.3600

3,6 V

1.500 mAh

300 rpm

USB-C

2+ LED

EINMAL BERÜHRT, FÜR IMMER VERFÜHRT.

| | | |
|----|--|--------------------------|
| 4x | | 3,0 - 4,0 - 5,0 - 6,0 mm |
| 4x | | 3,0 - 4,0 - 5,0 - 6,0 mm |
| 5x | | PH0 - PH1 - PH2 - PH3 |
| 4x | | PZ0 - PZ1 - PZ2 - PZ3 |
| 4x | | T10 - T15 - T20 - T25 |
| 4x | | H0 - H1 - H2 - H3 |
| 1x | | PH1 |
| 1x | | 50 mm |
| 1x | | Max. 6 Nm |



Weitere Informationen

DER ALLROUNDER



1 Bohren



2 Reinigen



3 Schleifen



4 Gravieren

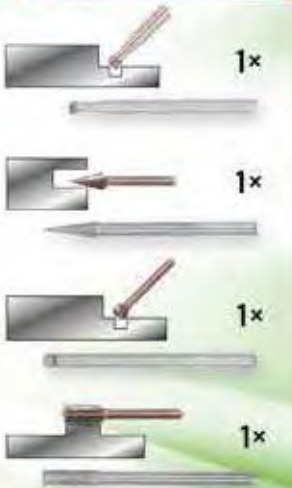

5 Trennen



6 Polieren



eMONSTER
Akku-Multifunktions-
werkzeug-Satz mit
50 Zubehörteilen

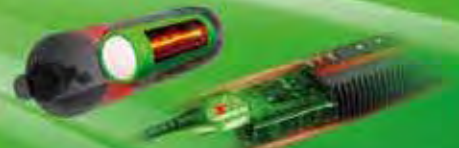

eMONSTER



49,90

515.3990



Weitere Informationen

ZUM NACHKAUFEN



Zubehör-Satz, 50-tlg

9,90

515.3992

DER TRANSFORMER UNTER DEN SCHRAUBERN



e**MONSTER**

**Hohe 210 RPM
Drehzahl, dadurch
5 x schneller als
manueller
Anziehvorgang**

praktische Batterie-
Ladezustandsanzeige
mit 3 LEDs

verstärktes
Getriebe



2 in 1 Gerät mit ausgewogenem Verhältnis zwischen Leistung und Größe, ideal zum Arbeiten über Kopf und an engen Stellen.

magnetische
Bitaufnahme



Drehmomentvorwahl in
10 Stufen einstellbar



verbesserter
Griffkomfort



**1.3 Ah Akku
mit einer Laufzeit
für
1000+
Schrauben**

Der Li-ION-Hochleistungsakku
ist dank USB-C Anschluss auch
schnell wieder aufgeladen und
einsatzbereit.

integrierte Lampe



Ein Überdrehen der Schrauben wird
durch automatisches Verriegeln
des Motors bei Überschreiten des
Drehmoments verhindert.

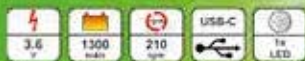

Weitere Informationen

**inkl.
25 Bits**



39,90

515.6500

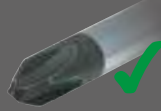

verchromt mit
brünierter Spitze



mit Profilkennzeichnung
am Griff

i **5**
Weitere Informationen

159.0005

9,90

PH1 PH2 6,5 mm 5,5 mm 4 mm

i **6**
Weitere Informationen

159.0030

19,90

T10 T15 T20 T25 T30 T40

i **6**
Weitere Informationen

159.0040

19,90

TB10 TB15 TB20 TB25 TB30 TB40

i **39**
Weitere Informationen

50,90

| | | | | | |
|-----|--|--------------------------------|-----|--|--|
| 6 x | | 3 - 4 - 5,5 - 6,5 8 - 10 mm | 7 x | | 2 - 2,5 - 3 - 4 - 5 6 - 8 mm |
| 5 x | | PH0 - PH1 - PH2 PH3 - PH4 | 7 x | | TB10 - TB15 - TB20 TB25 - TB27 - TB30 TB40 |
| 4 x | | PZ0 - PZ1 - PZ2 PZ3 | 7 x | | T10 - T15 - T20 T25 - T27 - T30 T40 |
| 1 x | | 6 mm | 1 x | | 1/4" |
| 1 x | | PH2 | 1 x | | 205 mm |

159.0100 **1/4"**

i **13**
Weitere Informationen

**DER VERTRÄGT
SCHLÄGE!**

67,90

durchgehende Klinge

| | | |
|-----|--|-----------------------------|
| 5 x | | 3,5 - 5,5 - 7 - 8 - 10 mm |
| 5 x | | PH0 - PH1 - PH2 - PH3 - PH4 |
| 1 x | | 6 mm |
| 1 x | | PH2 |
| 1 x | | 1/4" |

151.1150 **1/4"**

i **15**
Weitere Informationen

260 mm



A

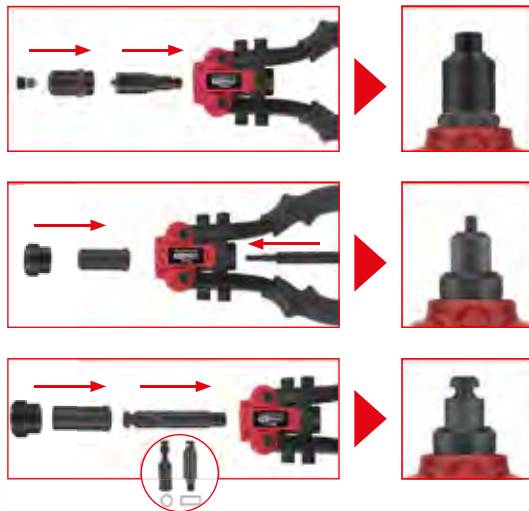

67,90

150.9805



Niete (Alu)



Niete (Stahl)



Mutter

| | | A | B |
|--|----------------------------------|----------|----------|
| | | 150.9805 | 150.9630 |
| | im Koffer | ✓ | ✓ |
| | Länge mm | 260 | 510 |
| | Blechknabber | ✓ | ✗ |
| | Ein- oder Zweihand- Bedienung | | |
| | M10 | ✓ | ✓ |
| | M8 | ✓ | ✓ |
| | M6 | ✓ | ✓ |
| | M5 | ✓ | ✓ |
| | M4 | ✓ | ✓ |
| | M3 | ✓ | ✓ |
| | Stahl 4,8 mm | ✓ | ✓ |
| | Stahl 4,0 mm | ✓ | ✓ |
| | Stahl 3,2 mm | ✓ | ✓ |
| | Stahl 2,4 mm | ✓ | ✓ |
| | ALU 6,4 mm | ✓ | ✓ |
| | ALU 4,8 mm | ✓ | ✓ |
| | ALU 4,0 mm | ✓ | ✓ |
| | ALU 3,2 mm | ✓ | ✓ |
| | ALU 2,4 mm | ✓ | ✓ |

i **17**
Weitere Informationen



B



3 x
8,5 x 5,5 - 17 x 12 - 19 x 15 mm

5 x
M4 - M5 - M6 - M8 - M10

6 mm

174,90

150.9630





1
Weitere Informationen









ab 10,⁹⁰







| | ↔ | ↔ | |
|----------|--------|-----|---------------------|
| 115.2011 | 175 mm | 7" | 10, ⁹⁰ € |
| 115.2010 | 240 mm | 10" | 12, ⁹⁰ € |
| 115.2012 | 300 mm | 12" | 15, ⁹⁰ € |
| 115.2016 | 415 mm | 16" | 31, ⁹⁰ € |

4
Weitere Informationen

| | | | | |
|-----|---------------|---------------|---------------|---------------|
| CrV | DIN 5254 A | DIN 5254 B | DIN 5256 C | DIN 5256 D |
|-----|---------------|---------------|---------------|---------------|

PREMIUM QUALITÄT!

4
Weitere Informationen



A 19 - 60 mm



B 40 - 100 mm

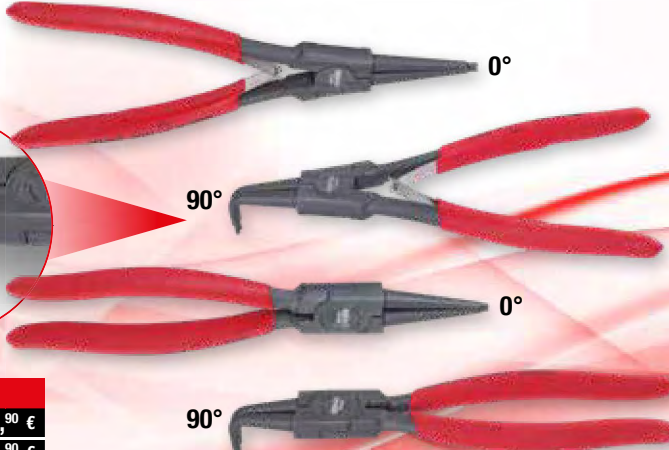

ab 110,⁹⁰

| | ↺ ↻ | ↔ | |
|----------|----------|-------------|--------|
| A | 119.2055 | 19 - 60 mm | 160 mm |
| B | 119.2060 | 40 - 100 mm | 230 mm |





20
Weitere Informationen

SAFETY FIRST



60 - 100 mm



40 - 85 mm



49,⁹⁰







500.1350
Sicherungszangen-Satz mit Ratschenfunktion

i **10**
Weitere Informationen

SCHAU MIR IN DIE AUGEN, FEINES!

i **21**
Weitere Informationen

24,90

260 mm

300 mm

| | | | |
|-----|--------|-----|--------------------|
| 1 x | 120 mm | 1 x | 160 mm |
| 1 x | 120 mm | 3 x | PH00 - PH0 - PH1 |
| 1 x | 120 mm | 3 x | 2,0 - 2,4 - 3,0 mm |

500.7220

99,90

ESD

430 mm

370 mm

| | | | |
|-----|--------------|-----|-------------------------------------|
| 2 x | 125 - 130 mm | 3 x | PH00 - PH0 - PH1 |
| 1 x | 100 mm | 4 x | 1,4 - 2,0 - 2,4 - 3,0 mm |
| 1 x | 100 mm | 7 x | T6 - T7 - T8 - T9 - T10 - T15 - T20 |
| 1 x | 125 mm | | |
| 1 x | 150 mm | | |
| 1 x | 145 mm | | |

500.7190

i **1**
Weitere Informationen

500g

mit stabiler, reissnadelähnlicher Einstellspitze

Ø 8,0 mm

150 - 675 mm

5,90

mit starrem Magnet-Kopf

550.1001 2in1 Teleskop-Magnethalter mit Waschdüsen-Reinigungs- und Einstellwerkzeug

i **1**
Weitere Informationen

2,5 kg

mit dünnem Reinigungsstab

Ø 11,0 mm

150 - 590 mm

7,90

mit flexiblem Magnet-Kopf

550.1023 2in1 Teleskop-Magnethalter mit Waschdüsen-Reinigungs- und Einstellwerkzeug

i **1**
Weitere Informationen

9,90

50 x 80 mm

260 - 760 mm

max. 60 h

1 x CR 2032

LED

550.1136 Flexibler Inspektions-Spiegel mit Beleuchtung

i **5**
Weitere Informationen

LED

3 x LR44

Ø 52,0 mm

Ø 31,0 mm

90,0 x 50,0 mm

14,90

5 IN 1

inklusive Schnellverriegelung

3,6 kg

172 - 640 mm

550.1145

i **4**
 Weitere Informationen

9,90

45° 135° 0° 90°

550.1045

i **9**
 Weitere Informationen

19,90

45° 135° 0° 90° 45° 90° 0°

550.1070

i **1**
 Weitere Informationen

8,90

Piezo

115 mm

960.1110

i **1**
 Weitere Informationen

19,90

300 mm

550.1060

i **8**
 Weitere Informationen

19,90

95 mm

Ø 40 mm

49 mm

5 mm

Ø 1,6 mm

Ø 3,5 mm

Ø 4,5 mm

960.1265

i **11**
 Weitere Informationen

29,90

Piezo

200 mm

20 mm

33 mm

Ø 1,6 mm

Ø 3,5 mm

Ø 4,5 mm

Ø 5 mm

30 mm

95 mm

95 mm

Ø 40 mm

ISO BUTAN

960.1160 Mikro-Löt-Satz

i **283**
Weitere Informationen

169,90

220 mm

Ø 0,5 - 6 mm Ø 0,5 - 6 mm

Ø 0,5 - 10 mm Ø 6,50 / 5,41 / 1,72 mm Ø 0,5 - 4 mm

Ø 1,0 - 3,2 mm

115.1400

i **1**
Weitere Informationen

3,90

143 mm

118.0013

i **1**
Weitere Informationen

ab 2,90

EG II

A 16 mm B 19 mm C 25 mm D 25 mm

| | 300.0113 | 300.0114 | 300.0115 | 300.0116 |
|---|----------|----------|----------|----------|
| A | 3 m | 5 m | 5 m | 8 m |
| B | 16 mm | 19 mm | 25 mm | 25 mm |
| C | 2,90 € | 3,90 € | 4,90 € | 5,90 € |

3 m 5 m 5 m 8 m

i **5**
Weitere Informationen

29,90

260 mm

Temperaturregulierung:
1≈50°C / 2≈100°C / 3≈200°C /
4≈350°C / 5≈550°C / 6≈650°C

1 max. 450°C
2 max. 650°C

Anwendungsgebiete: Entfernen von Farbe, Verlöten von Rohren, Schrumpfen von PVC, Verschweißen und Biegen von Kunststoffen, Trocknungen, Auftauen etc.

960.1190

i **1**
Weitere Informationen

134,90

IP 34

15+1 m

3x 1,5 mm²

230 V 50 Hz

1000/3000 W

10 A

180°

150.4217

i **12**
Weitere Informationen

9,90

145 mm

5,0 x 1,0 mm
5,0 x 1,0 mm
3,0 mm
3,0 mm
5,0 mm
5,0 mm
3,0 mm
2,0 mm
2,0 mm
5,0 mm
5,0 mm
5,0 mm

140.3050

i **5**
Weitere Informationen

29,90

200 mm

140.3000

i **1**
Weitere Informationen

138 x 69 x 31 mm
 342 g
 9 V

19,90

69 mm
138 mm

150.1495

i **1**
Weitere Informationen

3 - 48 V

140 mm

11,90

550.1503 **Polaritäts- und Spannungsprüfer 3 - 48 V**

i **1**
Weitere Informationen

125 mm

6 - 24 V

4,90

550.1504 **Prüflampe 6 - 24 V**

i **1**
Weitere Informationen

AUTOMATIC DIGITAL MULTIMETER

143 x 70 x 16 mm
 119 g
 AAA

16 mm

143 mm

70 mm

49,90

150.1765

Nr. Beschreibung

- Ein-/Aus-Taste
- Funktionsschalter
- Kapazitätsschalter
- Beleuchtungsschalter
- LCD-Display
- NCV-Sensor-Bereich
- Messleitungen

Symbol Beschreibung

| | |
|-------------------|---|
| | Gleichspannung |
| | Wechselspannung |
| | Anzeige für automatische Abschaltfunktion |
| | Anzeige für niedrigen Batteriestand |
| | Dioden-Modus |
| | Durchgang |
| | Kapazität |
| | Leistungsmessverhältnis |
| HOLD | Data-Hold-Funktion |
| V, mV | Einheit der Spannung: Volt, Millivolt |
| mF, µF, nF | Einheit der Kapazität |
| MΩ, KΩ, Ω | Einheit des Widerstands |
| NCV | Kontaktlose Spannungsinduktion |
| Live | Prüfung spannungsführender Leitungen |
| KHz, Hz | Einheit der Frequenz |
| °C/°F | Celsius/Fahrenheit |

NCV

3 COLOUR ANALOG BAR

BUZZER ALARM

USB-A

USB-C

i **3**
Weitere Informationen

210 x 88 x 44 mm
655
9 V
Data Hold

34,90

max. messbarer Leiterdurchmesser 29,0 mm

150.0925

i **1**
Weitere Informationen

für Gleich- und Wechselspannung

| | |
|----|----------------------------|
| AC | 6 - 50 - 120 - 230 - 400 V |
| DC | 6 - 50 - 120 - 230 - 400 V |

23,90

550.1501

UNIVERSAL-SCHLTSCHRANKSCHLÜSSEL

i **1**
Weitere Informationen

MINI

42 mm

- 6 - 7 - 8 mm
- ▲ 9 mm
- 3 - 5 mm
- ⊕ PH 2
- ⊖ 7 mm

16,90

130.1010

i **1**
Weitere Informationen

71 mm

- 6 - 7 - 8 mm
- ▲ 9 mm
- 3 - 5 mm
- ⊕ PH 2
- ⊖ 7 mm

17,90

130.1015

i **1**
Weitere Informationen

61 mm

- 5 - 7 - 8 mm
- ▲ 9 - 10 mm
- 4 - 10 mm
- ⊕ PH 2
- ⊖ 7 mm

17,90

130.1020

Kabel-Einziehdraht

10 Meter
20 Meter

ab 4,90

| | | | | | |
|----------|----------|--|----------|------------------|--------|
| A | 150.0960 | | 1 | ∅ 3,0 mm 10 m | 4,90 € |
| B | 150.0970 | | 1 | ∅ 4,0 mm 20 m | 9,90 € |

i **1**
Weitere Informationen

34,90

∅ 3,0 mm

30 Meter

115.1113 Kabeleinziehilfe

i  **1**
Weitere Informationen

22,90



- mit Momentfeststellung
- Messschiene in mm und Zoll-Teilung
- mit Gewindetabelle

300.0510

i  **1**
Weitere Informationen

24,90



$\pm 0,03 \text{ mm}$

- mit Feststellschraube und Rollenfeineinstellung
- für Außen-, Innen-, Stufen- und Tiefenmessungen

300.0532

i  **1**
Weitere Informationen

INFRAROT-THERMOMETER, -38° BIS 520°



49,90

150.3040

i  **4**
Weitere Informationen

56,90



Refraktometer - optisches Prüfgerät für Batterieflüssigkeit und Frostschutzmittel

550.1290

i  **4**
Weitere Informationen

67,90



Refraktometer - optisches Prüfgerät für Batterieflüssigkeit, Frostschutzmittel und AdBlue®-Zusätze

550.1285

i **4**
Weitere Informationen

19,90

11 x 115 mm
15 x 185 mm
18 x 320 mm
18 x 470 mm

911.8100 Hebeleisen-Satz

i **4**
Weitere Informationen

XL

900 mm
600 mm

0°
45°
75°
90°

179,90

911.8410 Hebeleisen-Satz

i **22**
Weitere Informationen

Hydraulischer Universal-Abzieher-Satz 2+3-armig

- geringe Abrutschgefahr durch automatisch schließende Abzieherarme
- 8 Abziehervarianten möglich
- extrem robuste Spindel mit induktiv gehärtetem Gewinde
- geringer Kraftaufwand
- Spezial-Werkzeugstahl

304,90

700.1200

20 - 35 - 85 mm
235 mm
185 mm
10 t, AG 1.1/2" x 16G
Ø max. 100 mm
225 mm
170 mm
120 mm

i **13**
Weitere Informationen

NEU

FÜR NOTFÄLLE

79,90

0% ✓ 85% ✓

zum Lösen und Herausdrehen von feststehenden Muttern und Schrauben mit beschädigten oder bis zu 85% „rundgedrehten“ Köpfen

89,90

Ringe 45° gekröpft

913.3930 8 - 9 - 10 - 11 - 12 - 13 - 14 - 15 - 16 - 17 - 18 - 19 mm **3/8"**

517.1555 6x7 - 8x9 - 10x11 - 12x13 - 14x15 - 16x17 - 18x19 mm

3/8"

1/2"

ICH BIN EINE SCHRAUBE, HOLT MICH HIER RAUS!



Weitere Informationen

- für Schrauben von M3 - M18
- ermöglicht das Ausdrehen von abgerissenen Schrauben und Bolzen
- konisch zulaufende Spirale
- in stabiler Kunststoffbox

16,90



150.1330 Schrauben-Ausdreher-Satz



Weitere Informationen

TORXION power

44,90

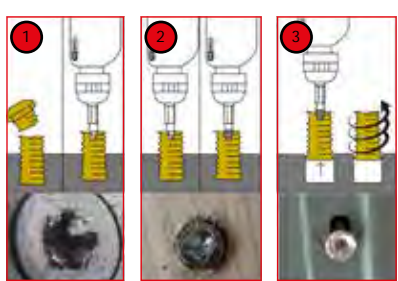

| | | |
|-----|--|--|
| 9 x | | TE10 - TE15 - TE20 - TE25 - TE27 - TE30 - TE40 - TE50 - TE55 |
| 9 x | | 1,5 - 2 - 2,5 - 3 - 4 - 5 - 6 - 8 - 10 mm |
| 7 x | | 1,5 - 2 - 2,5 - 3 - 4 - 5 - 6 mm |
| 7 x | | T10 - T15 - T20 - T25 - T27 - T30 - T40 |

150.7060 1/4" + 10 mm Torx- und Innensechskant-Schrauben-Ausdreher-Satz



Weitere Informationen

Gewindeausdreh-Satz

- umfangreiche Satzzusammenstellung
- zum Entfernen von abgebrochenen Gewindebolzen und Schrauben
- keine Beschädigung des Gewindes
- nur geringfügiges Aufweiten der Gewindebolzen durch speziell profilierte Ausdrehstifte

| Führungshülse drill guide | Hülse Innen-Ø mm guide | vorböhren Ø mm pre-drilling | aufbohren re-drilling | Stift pin | Art.Nr. Stift No. Pin | Mutter D nut D | Art.Nr. Mutter nut D | Stift + Mutter pin + nut |
|---------------------------|------------------------|-----------------------------|-----------------------|-----------|-----------------------|----------------|----------------------|--------------------------|
| 150.0501 | 4,0 / 3,2 | 3,2 | - | 3,2 | 150.0521 | SW 10 | 150.0511 | 150.0511S |
| 150.0502 | 4,8 / 3,2 | 3,2 | - | 3,2 | 150.0521 | SW 10 | 150.0511 | 150.0511S |
| 150.0503 | 4,8 / 3,2 | 3,2 | 4,8 | 4,8 | 150.0522 | SW 11 | 150.0512 | 150.0512S |
| 150.0504 | 4,8 / 3,2 | 3,2 | 4,8 | 4,8 | 150.0522 | SW 11 | 150.0512 | 150.0512S |
| 150.0505 | 6,0 / 4,8 | 4,8 | 6,4 | 6,4 | 150.0523 | SW 13 | 150.0513 | 150.0513S |
| 150.0506 | 7,0 / 4,8 | 4,8 | 6,4 | 6,4 | 150.0523 | SW 13 | 150.0513 | 150.0513S |
| 150.0507 | 7,0 / 4,8 | 4,8 | 8,0 | 8,0 | 150.0524 | SW 14 | 150.0514 | 150.0514S |
| 150.0508 | 7,0 / 4,8 | 4,8 | 8,7 | 8,7 | 150.0525 | SW 17 | 150.0515 | 150.0515S |
| 150.0509 | 9,0 / 6,5 | 6,4 | 8,7 | 8,7 | 150.0525 | SW 17 | 150.0515 | 150.0515S |
| 150.0510 | 9,5 / 6,5 | 6,4 | 8,7 | 8,7 | 150.0525 | SW 17 | 150.0515 | 150.0515S |



150.1305 M5 - M6 - M8 - M10 - M12 - M14 - M16

39,90

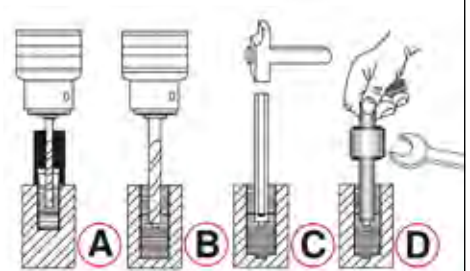



Weitere Informationen

Stehbolzen-Ausdreher-Satz

- Außensechskantantrieb 21,0 mm
- mit Rechts- und Linksspannfunktion
- sicherer Halt durch je 3 Rollwalzen
- Ein- und Ausdrehen ohne umständliches Verkontern zweier Muttern auf dem Bolzen
- auch für überlange Stehbolzen geeignet - da durchgehend gebohrt

49,90



152.1101 M5 - M6 - M7 - M8 - M10 - M12 - M14



Weitere Informationen

HSS Co Gewindeschneidwerkzeug-Satz in Industriekassette

- universaler Satz
- gerade genutete Handgewindebohrer
- mit verstellbarem Windeisen und Schneideisenhalter
- inklusive Gewindelehre und Schraubendreher
- kobaltierter Hochleistungs-Stahl



DEM FEHLT ES AN NICHTS



| | | |
|------|--|--|
| 33 x | | M3 - M4 - M5 - M6 - M8 - M10 - M12 M14 - M15 - M18 - M20 |
| 11 x | | M3 - M4 - M5 - M6 - M8 - M10 - M12 M14 - M15 - M18 - M20 |
| 6 x | | M3-M4 - M4,5-M6 - M7-M9 - M10-M11 - M12-M14 - M16-M20 |
| 2 x | | M1-M10 - M5-M20 |

499,90

331.0754



Weitere Informationen

TRÄGT JEDER GERNE!

24,90



EN388



4131X

Mikro-Feinstrick

| | Größe | Inhalt |
|----------|-------|---------|
| 310.0490 | 7 | 12 Paar |
| 310.0491 | 8 | 12 Paar |
| 310.0470 | 9 | 12 Paar |
| 310.0475 | 10 | 12 Paar |
| 310.0480 | 11 | 12 Paar |



Weitere Informationen

3,90



310.0120

FLAME DESIGN

Weitere Informationen





49,90

310.0155

STEEL DESIGN

Weitere Informationen



49,90

310.0195



Technische Daten:

| | |
|------------------------|---|
| Farbauswahl: | stufenlos regelbar von DIN 9-13 Standard Lichteinstellung: DIN 4 |
| Umschaltreaktionszeit: | 1/25.000 s 0,2 - 0,8 s Verzögerung (einstellbar) |
| UV / IR Schutz: | nach EN169 / bis DIN 16 |
| Betriebstemperatur: | -5°C bis + 55°C |
| Lagertemperatur: | -20°C bis + 70°C |
| Stromversorgung: | über Solarzellen |
| Höhe: | 220 mm |
| Breite: | 200 mm |
| Länge: | 295 mm |
| Gewicht: | 480 g |
| Maße Kassette: | 110 x 90 x 9 mm |
| Sichtfenster: | 92 x 42 mm |

Universal-Druck-Zerstäuber

Weitere Informationen

- aus hochwertigem Polyethylen
- für verschiedene Chemikalien wie z.B. Wasch-, Lösungs- und Reinigungsmittel etc.
- für Bremsenreiniger ungeeignet
- Sprühkopf aus Messing verstellbar und verschleißbar
- Dichtungen aus Viton®
- geeignet für Überkopf-Arbeiten



für Bremsenreiniger ungeeignet

ab 14,90

| | | |
|----------|-----|---------|
| 150.8251 | 1 L | 14,90 € |
| 150.8252 | 2 L | 19,90 € |

Aluminium

Weitere Informationen

0,25 L
max. 8 bar (116 psi)
60°C / 140°F

115 mm

NEU

Speziell für Bremsenreiniger

49,90

150.8272

i **16**
Weitere Informationen

EVOLUTION SERIES

Schaber-Satz

- ideal zum Entfernen von Plaketten, Dichtungs- und Klebstoffresten
- einfacher Klingenwechsel durch Lösen der Rändelschraube am Spannfutter
- praktisches Aufbewahrungssystem durch wechselbare Klingensformen
- bestens geeignet für unterschiedlichste Anwendungsbereiche durch verschiedene Klingen
- Schaber mit 2-Komponentengriff

Ersatzklingen: 907.2202, 907.2203, 907.2204, 907.2205, 907.2206

NEU

5x 12 mm
5x 16 mm
5x 20 mm

145 mm

12,90

907.2255

i **27**
Weitere Informationen

Messer-Schaber-Satz

145 mm

5x 19 mm

5x 12 mm
5x 16 mm
5x 16 mm
5x 20 mm

145 mm

19,90

907.2200

Plaketenschaber

A **B**

110 mm 145 mm

ab 3,90

| | | | | | | |
|----------|----------|--|--|---|-------------|--------|
| A | 907.2240 | | | 1 | 110 x 39 mm | 3,90 € |
| B | 907.2242 | | | 1 | 145 x 40 mm | 4,90 € |

Klappmesser mit Arretierung

A **B**

190 mm 220 mm

ab 10,90

| | | | | | | |
|----------|----------|--|--|---|-------------|---------|
| A | 907.2105 | | | 1 | 190 x 25 mm | 10,90 € |
| B | 907.2190 | | | 1 | 220 x 28 mm | 11,90 € |

i **2**
Weitere Informationen

14,90

155 mm 97 mm

+

907.2172 **Klappmesser-Satz**

i **3**
Weitere Informationen

39,90

250 mm

+ **+**

118.0050 **Hebel-Blechdurchgangsscheren-Satz**

Wi-Fi-Videoskop-Satz mit Ø 5,5 mm 0° HD Frontkamera-Sonde

5 Weitere Informationen

HD

WiFi

Ø 5,5 mm

Ø 5,5 mm

3500 mm

IP68

39,90

550.7560

EXTEND YOUR EYE

ab 239,90

Edelstahlhülse
Schraubanschluss
für Zubehör

Kronendesign
(Schutz +
optimale
Reinigung)

Kamera
Linse
LED
Edelstahlhülse
mit Außengewinde
Saphirglas

1500 mAh
Li-polymer

Ø 6,0 mm

Ø 4,5 mm

1000 mm

Anschluss Sonde

3,5"

USB 2.0

microSD

HD

6 dimmbare
Mini-LED-
Lampen

Ø

0° 90°

1000 mm

50 mm

IP 67

AVI
1280 x 720

JPG

150 mm

-10°/+60°C

Magnet

Magnet

Haken

| | | | | | |
|----------|----------|----------|---------------|----------|-----------------|
| A | 550.7500 | 5 | 6,0 mm | 0° + 90° | 239,90 € |
| B | 550.7530 | 7 | 4,5 mm | 0° + 90° | 299,90 € |



i  **3**
Weitere Informationen

Ø
3,9 mm

6 dimmbare
Mini-LED-
Lampen

1000 mm
90 mm

0°
steuerbar
180° 180°

drehbar
drehbar
360°

Anschluss Sonde

USB 2.0

microSD



3000 mAh
Li-polymer

IP
67

AVI
1280 x 720

JPG

150 mm

-10°/+60°C

NEU

449,⁹⁰

+ 32 GB

550.7550 HD-Videoskop-Satz mit Ø 3,9 mm 180° und 0° HD Frontkamera-Sonde, flexible PVC Hülle





Ø 12 - 35 MM

104.5060 **Inox** **Steel**

Ratschen-Rohrabschneider

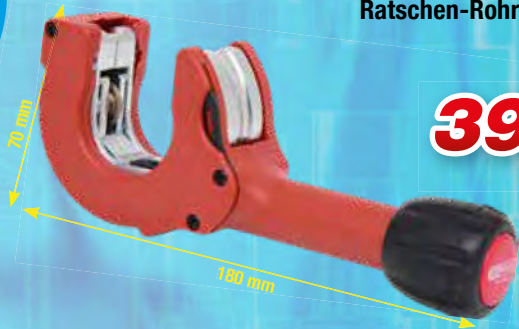

39,90



Ø 28 - 67 MM

104.5050 **Inox** **Steel**

Ratschen-Rohrabschneider



129,90

116.1050

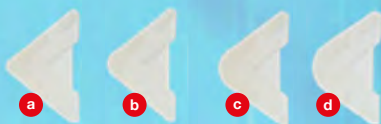

FUGENFIX®

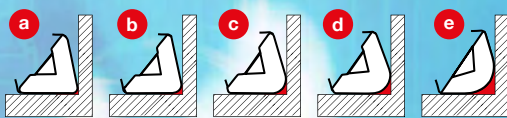

7,90

FUGENFIX Silikonschaber- und Abziehersatz



903.3300

Gewinde-Schneidkluppen-Satz

3/8"
1/2"
3/4"
1"
1.1/4"

79,90



116.2000



57,90

Ventilfix

130.3000

1/2"



3/8" - 1/2"
3/4" - 1"

90 mm



270 mm

19,90

Universal-Stufenschlüssel-Satz 3/8" - 1"

903.5902

- Flammentemperatur ca. 1700°C
- Arbeitstemperatur ca. 650°C
- Weichlöten bis max. Ø 22 mm
- Lieferung erfolgt ohne Gaskartusche
- Verwendung nur mit Standard-Hochleistungsbrenner
- Grundkörper aus Kunststoff



Piezo



24,90

Universal-Kartuschenlötgerät mit Piezo-Zündung

907.2113

Japan-Zugsäge,
doppelseitig



17x
pro 2,5cm

8x
pro 2,5cm

325 mm

17,90



850.0300

SMARTBAG Universal-
Werkzeugtasche

73,90

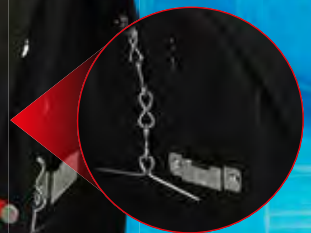

NEU



Kompakte und robuste Bauweise:

Durch hochwertige Kunststoffe und feste Verschraubungen, bietet der Akku besonders guten Schutz vor mechanischen Einflüssen.



18V eMONSTER Akku-System

Das kraftvolle 18V eMONSTER Akku-System vereint eine Reihe von professionellen akkubetriebenen Elektrowerkzeugen. Alle Geräte können mit einem Akku-System betrieben werden. Das Sortiment ist breit aufgestellt und wird stetig erweitert. Jedes neue Gerät kann ebenso mit diesem Akku-System genutzt werden. So können Sie über viele Jahre dieses Akku-System nutzen und mit eMONSTER 18V Geräten erweitern - Sie bleiben in einer Akku-Familie.



Wärmeableitung:

Durch die Rippenstruktur wird die Wärme wie bei einem Kühler an die Umgebungsluft angeleitet.



Zusätzlicher Schutz für eine lange Lebensdauer des Akkus:

Überspannungsschutz:

- Schutz vor unzulässig hohen Spannungsquellen

Niederspannungsschutz:

- Schutz vor Tiefenentladung im Betrieb

Temperaturmanagement:

- Zusammenspiel von Gerät und Akku, um eine Überlastung am Akku zu verhindern



Aktive Luftkühlung:

(nur bei 8.0Ah Schnellladegerät) Der integrierte Lüfter des 8.0Ah Schnellladegeräts liefert während dem Ladevorgang durchgehend kühle Frischluft, um entstehende Wärme im Akku und Ladegerät bestmöglich zu reduzieren. Durch diesen schonenden Ladevorgang wird die Lebensdauer des Akkus deutlich erhöht.



Optimierte Zellanordnung:

Durch die Röhrenstruktur werden die einzelnen Zellen in den wärmeleitenden Kunststoff geschoben. So entsteht ein fester Kontakt zwischen der Zelle und dem wärmeleitenden Kunststoff. Es ist keine isolierende Luftschicht mehr vorhanden, welche die Wärmeableitung verringert.





eMONSTER Brushless-Akku-Bohr-Schrauber-Satz

MINI



159,90

Drehmoment max: 40 Nm
Antrieb: 10 mm Schnellspann-Bohrfutter

515.6400



eMONSTER Brushless-Akku-Schlag-Bohr-Schrauber-Satz



189,90

Drehmoment max: 60 Nm
Antrieb: 13 mm Röhren-Metall-Schnellspann-Bohrfutter

515.6300

INKLUSIVE



Akkuspannung: 18,0 V
max. Ladestrom: 3 A

Akkuspannung: 18,0 V
Akkutechnologie: Lithium-Ionen
Akkukapazität: 2,0 Ah

Lieferung inkl. zwei 2,0 Ah Akkus und 3 A Schnellladegerät

INKLUSIVE



eMONSTER 1/2" Brushless-Akku-Schlag-Schrauber-Satz



269,90

max. Löse-Drehmoment: 690 Nm
Antrieb: 1/2"

515.6100



eMONSTER Brushless-Akku-Winkelschleifer-Satz



299,90

Drehzahl: 9000 U/min
Vibrationsbeschleunigung: < 4,831 m/s²
3,371 m/s²

515.6200

INKLUSIVE



Akkuspannung: 18,0 V
max. Ladestrom: 8 A

Akkuspannung: 18,0 V
Akkutechnologie: Lithium-Ionen
Akkukapazität: 4,0 Ah

Lieferung inkl. zwei 4,0 Ah Akkus und 8 A Schnellladegerät



NEU

1/4" TORSIONpower Bit-Satz im eMONSTER-Akku-Design, 32-tlg



9,90

515.6932

| | | |
|-----|--|--|
| 1 x | | 1/4" |
| 1 x | | 1/4" |
| 4 x | | 3 - 4 - 5 - 6 mm |
| 4 x | | PH1 - 2 x PH2 - PH3 |
| 4 x | | PZ1 - 2 x PZ2 - PZ3 |
| 4 x | | 3 - 4 - 5 - 6 mm |
| 7 x | | T10 - T15 - T20 - T25 - T27 - T30 - T40 |
| 7 x | | TB10 - TB15 - TB20 - TB25 - TB27 - TB30 - TB40 |



+30%

lässt sich an die 18V eMONSTER Geräte als Akku-Dummy anstecken und arretieren

HIER GEHT'S SCHLAG AUF SCHLAG!

1.390 N·m

1/2"

90 mm

165 mm

515.1150

1  **199,90**

1.390 N·m

1/2"

95 mm

190 mm

515.1270

2  **149,90**

1.084 N·m

1/2"

115 mm

180 mm

515.1315

3  **69,90**

1.600 N·m

1/2"

170 mm

188 mm

515.1200

4  **69,90**

2.000 N·m

3/4"

170 mm

185 mm

515.3400

5  **124,90**

1.690 N·m

1/2" 3/4"

175 mm

200 mm

515.1210

6  **149,90**

7  **189,90**

3.405 N·m

3/4" 1"

40 mm

350 mm

515.3250

9  **849,90**

11  **849,90**

3.405 N·m

3/4" 1"









195 mm

350 mm

515.3260

10  **904,90**

12  **904,90**

| | |  |  |  |  |  |  |  |  |  |  |  | |
|----|----------|---|---|---|---|---|---|---|---|---|---|---|------|
| | | MAX. Nm | U/min | m/s ² | dB(A) | dB(A) | U/min | PT | | | | Kg | |
| 1 | 515.1150 | 1/2" | 1390 | 10.000 | <9,18 | 102,0 | 113,0 | 135 | 1/4" | - | ✓ | - | 1,08 |
| 2 | 515.1270 | 1/2" | 1390 | 10.000 | <9,18 | 102,0 | 113,0 | 135 | 1/4" | - | ✓ | - | 1,3 |
| 3 | 515.1315 | 1/2" | 1084 | 9000 | <10,36 | 106,0 | 115,0 | 169 | 1/4" | - | ✓ | - | 1,2 |
| 4 | 515.1200 | 1/2" | 1600 | 8500 | <17,5 | 89,9 | 100,9 | 169 | 1/4" | ✓ | - | - | 2,1 |
| 5 | 515.3400 | 3/4" | 2000 | 8500 | <17,25 | 91,0 | 100,9 | 196 | 1/4" | ✓ | ✓ | - | 2,2 |
| 6 | 515.1210 | 1/2" | 1690 | 7930 | <17,9 | 87,0 | 98,0 | 178 | 1/4" | ✓ | ✓ | - | 2,1 |
| 7 | 515.3785 | 3/4" | 1690 | 7930 | <13,56 | 88,0 | 104,0 | 178 | 1/4" | ✓ | ✓ | - | 2,2 |
| 8 | 512.0002 | 1/2" | 2300 | 8500 | <8,69 | 99,7 | 110,9 | 244 | 1/4" | ✓ | ✓ | ✓ | 1,6 |
| 9 | 515.3250 | 3/4" | 3405 | 6200 | <12,57 | 115,5 | 104,5 | 283 | 1/2" | ✓ | ✓ | - | 6,7 |
| 10 | 515.3260 | 3/4" | 3405 | 6200 | <12,88 | 115,5 | 104,5 | 283 | 1/2" | ✓ | ✓ | - | 7,7 |
| 11 | 515.3270 | 1" | 3405 | 6200 | <12,57 | 115,5 | 104,5 | 283 | 1/2" | ✓ | ✓ | - | 6,7 |
| 12 | 515.3280 | 1" | 3405 | 6200 | <12,88 | 115,5 | 104,5 | 283 | 1/2" | ✓ | ✓ | - | 7,8 |

MIT BI-TURBO VOLLE 2.300 NM IN NUR ~ 15 SEKUNDEN!

170 mm

185 mm



Hochleistungs-Doppel-Hammer-Schlagwerk

ROCKET II 2300 V8 BITURBO

ZWEI LUFTKANÄLE, DOPPELTE LEISTUNG!

Zwei Luftkanäle befeuern den starken mit 8 Lamellen betriebenen Biturbo-Motor. Sie können sich das vorstellen wie beim Auto: Zuerst springt der eine Turbo an und etwas später setzt sich das zweite Triebwerk in Gang und sorgt so für einen zusätzlichen Leistungsschub.



BITURBO

V8 = 8 STATT 6 ROTORBLÄTTER



512.0002



139,⁹⁰

DURCHDACHTE ABLUFTFÜHRUNG



| | | | | | | | | | | | | |
|---------|-----------|--------------|-------------|--------------|-----------|---------|----------------|--------|------------------------|-----------|----------|-----------|
| | | | | | | | | | | | | |
| 1/4" PT | 8.500 rpm | max. 2300 Nm | max. 851 Nm | max. 1256 Nm | 244 L/min | 6,3 bar | 3,8" - 10,0 mm | 1,6 kg | <8,69 m/s ² | 110,9 dbA | 99,7 dbA | max. M 16 |

2. GENERATION - 2. GENERATION - 2. GENERATION - 2. GENERATION - 2. GENERATION - 2. GENERATION

i 1
Weitere Informationen

Fettförderung: Je ein Hub pro Abzugsbetätigung

200 mm

400 g

400 mm

66,50

515.3900 **Druckluft-Fettpresse für hubweise Fettförderung**

i 1
Weitere Informationen

ab 24,90

PU ✓

| | | | | |
|----------|---------|----------|--------|---------|
| 515.3330 | 6,0 mm | G1/4" AG | 8,0 m | 24,90 € |
| 515.3335 | 8,0 mm | G1/4" AG | 15,0 m | 34,90 € |
| 515.3340 | 10,0 mm | G3/8" AG | 15,0 m | 39,90 € |

i 1
Weitere Informationen

9,90

regulierbar

100 mm

Druckluft-Ausblaspistole mit Durchflussregulierung

515.1901

i 3
Weitere Informationen

19,90

510 mm

330 mm

95 mm

Druckluft-Ausblaspistolen-Satz

515.1921

Automatischer Druckluftschlauch-Aufröller

15 m

1,5 m

180°

STOP

i 1
Weitere Informationen

119,90

Ø 10 MM X 15 M

A

Technische Daten:
Schlauchinnendurchmesser: 10,0 mm
max. Druck: 20,0 bar
Anschlussgewinde: 1/4"

515.3440

i 1
Weitere Informationen

179,90

Ø 13 MM X 15 M

B

Technische Daten:
Schlauchinnendurchmesser: 13,0 mm
max. Druck: 20,0 bar
Anschlussgewinde: 3/8"

515.3445

i **1**
Weitere Informationen

A 480 mm 320 mm 36 mm
B 1.150 mm 550 mm 36 mm

ab 11,90

| | | | |
|----------|----------|----------|---------|
| A | 500.8040 | 480 mm | 11,90 € |
| B | 500.8045 | 1.150 mm | 39,90 € |

i **1**
Weitere Informationen

1 360 mm 365 mm 360 mm

49,90

500.8020

i **1**
Weitere Informationen

2 400 - 540 mm

59,90

500.8030

i **1**
Weitere Informationen

HOCHBELASTBAR MIT 135 KG

3 463 - 580 mm

69,90

500.8004 360 mm

i **1**
Weitere Informationen

4 490 mm 1.040 mm 85 mm

69,90

500.8011

i **1**
Weitere Informationen

6 145 mm 420 mm 1.200 mm

99,90

500.8000

| | 1 | 2 | 3 | 4 | 5 | 6 |
|--------------------------|------------|------------------|------------------|-----------------|------------|------------------|
| Technische Daten: | 500.8020 | 500.8030 | 500.8004 | 500.8011 | 500.8090 | 500.8000 |
| Farbe | rot | rot | rot | rot | rot | rot |
| Material | Stahlrohr | Metall | Metall | Metall | Kunststoff | Metall |
| Anzahl Lenkrollen | 4 | 5 | 5 | 6 | 6 | 6 |
| rollbar | ✓ | ✓ | ✓ | ✓ | ✓ | ✓ |
| Art der Bereifung | Kunststoff | Kunststoff | Gummi | Kunststoff | Kunststoff | Kunststoff |
| gepolstert | ✓ | ✓ | ✓ | ✓ | ✗ | ✓ |
| höhenverstellbar | ✗ | ✓ | ✓ | ✓ | ✗ | ✓ |
| Verpackungsinhalt | 1 | 1 | 1 | 1 | 1 | 1 |
| Gesamtlänge L in mm | 365,0 mm | 370,0 mm | 360,0 mm | 1040,0 mm | 1030,0 mm | 1200,0 mm |
| Breite B | 360,0 mm | 370,0 mm | 360,0 mm | 490,0 mm | 480,0 mm | 420,0 mm |
| Höhe H | 360,0 mm | 420,0 - 540,0 mm | 463,0 - 580,0 mm | 85,0 - 400,0 mm | 115,0 mm | 145,0 - 510,0 mm |
| Gesamttragkraft kg | 90 kg | 90 kg | 135 kg | 90 kg | 120 kg | 90 kg |

i **1**
Weitere Informationen

DIE LEICHTESTE

5 480 mm 1.030 mm 115 mm

67,90

500.8090

i  **3**
Weitere Informationen

Genial flexibel

NEU

44,90

500.8077 **Werkzeugablagensatz aus Silikon**

1 **53 x 29,5 x 3,2 cm**

2 **25,5 x 23,3 x 2,4 cm**

3 **27,5 x 14,5 x 2,4 cm**

i  **1**
Weitere Informationen

- mit rutschfestem Profil auf der Laufbühne
- mit großer Plattform für sicheren Stand
- Kunststoffkanten an Füßen schützen Laufbühne und den Boden

99,90

800.0960 **Aluminium-Sicherheits-Laufbühne**

960 mm

300 mm

495 mm

max. 150 kg

FÜR IHRE SICHERHEIT

TÜV SÜD

GEPRÜFT!

i  **1**
Weitere Informationen

- mit Riffelblech-Profil auf der Trittstufe
- kein Kippen durch schräg gestellte Standfüße
- zusammenklappbar und dadurch platzsparend zu verstauen

54,90

800.0965 **Aluminium-Stufen-Stehleiter**

600 mm

440 mm

620 mm

max. 150 kg

FÜR IHRE SICHERHEIT

TÜV SÜD

GEPRÜFT!





1
Weitere Informationen

MAXIMALE ARBEITSFLÄCHE

1199,⁹⁰



840 mm

2000 mm

680 mm

XXL







1
Weitere Informationen

KLEIN UND GROSS ZUGLEICH!

179,⁹⁰



257 - 1380 mm

845 - 1320 mm

257 - 1380 mm











1
Weitere Informationen

NEU

49,⁹⁰



Ø 440 mm

180°

610 mm

570 mm

3 5000 rpm, 57 dB, 4,9 m/s, 56,9 W

2 4500 rpm, 51,5 dB, 4,3 m/s, 53 W

1 4000 rpm, 48 dB, 3,5 m/s, 49 W

EXTREM LEISE

ULTRALEICHT

< 3,5 KG

999.2000 **Werkstattventilator, 70 Watt**





1
Weitere Informationen

Parallel-Schraubstock

ab 165,⁹⁰



360°

360°
mit Drehteller

Backen und Amboss
induktiv gehärtet





| | | | |
|----------|--------|----|----------------------|
| 914.0004 | 120 mm | 4" | 165, ⁹⁰ € |
| 914.0005 | 140 mm | 5" | 178, ⁹⁰ € |
| 914.0006 | 160 mm | 6" | 189, ⁹⁰ € |
| 914.0008 | 200 mm | 8" | 229, ⁹⁰ € |

Alle Preise in EUR zzgl. MwSt. gelten bis 30.09.2024

53 

i

Weitere Informationen

| | |
|-------------------------|-----------------|
| | |
| max. 8 bar (116 PSI) | 60° C 140° F |

19,90

1 Water **2** Detergent **3**

Max. 40° C Max.

4 **5** Switch Lock

150.8271 Druck-Pump-Schaum-Sprüher (Schäumer)

i

Weitere Informationen

84,90

350 mm 650 mm

500.8013 Fahrbarer Hocker

i

Weitere Informationen

| | |
|---------|----------|
| | |
| 6,3 bar | 96 L/min |
| | |
| 92 dbA | 1/4" PT |

39,90

145 mm 3/8" - Ø 10 mm

saugen pusten

515.5090 Druckluft-Saug-Blaspistole

i **1**
Weitere Informationen

Ø 90 mm

M8

5,90

515.1243 **Folienradierer**

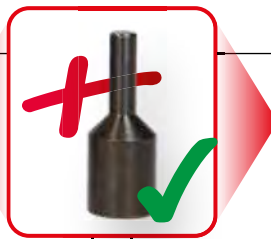

i **1**
Weitere Informationen

24 mm

Ø 100 mm

M8

15,90

515.1247 **Folienradierer mit Lamellen**

i **6**
Weitere Informationen

SETPREIS = 6x

29,90

515.1285



i **6**
Weitere Informationen

SETPREIS = 6x

89,90

515.1366

i **1**
Weitere Informationen

KSTOOLS
515.1980

ON - OFF

regulierbar

Industriekugellager

141,90

515.1980 **Druckluft-Reinigungs-Pistole**

| | | |
|-----------------|------------|--------------------|
| | | |
| 1/4" NPT | 8000 | 160 Liter |
| | | <3.90 min² icon"/> |
| 6,3 bar (90psi) | 3/8" 10 mm | <3,90 min² |
| | | |
| 106 dBA | 95 dBA | 1000 ml |

OPTIONAL

i **1**
Weitere Informationen

5,90

515.1983 **Bürsten-Aufsatz**

i **1**
Weitere Informationen

5,90

515.1986 **Bürsten-Pinsel**

i **6**
Weitere Informationen

29,90

510 mm

4 mm
8 mm
10 mm

4 mm
8 mm
10 mm

245 mm

150.2370 Clip-Löse-Satz

i **11**
Weitere Informationen

19,90

180 mm 200 mm 200 mm 200 mm 210 mm

160 mm 200 mm 200 mm 180 mm 200 mm 200 mm

911.6205 MASTER Kunststoffkeil-Satz

i **1**
Weitere Informationen

- beseitigt Gerüche und desinfiziert den Fahrzeuginnenraum
- automatische Abschaltung im Geruchs- beseitigungs-Modus nach 60 Minuten
- arbeitet ohne chemische Zusätze, daher ist eine rückstandslose Reinigung garantiert
- hinterlässt selbst auf empfindlichen Oberflächen keine Spuren
- beseitigt Schimmel, Bakterien, Pilze und Milben

173 mm

49 mm

122 mm

550.1183 Plasma-Luftreiniger mit Ionisator-Technik

79,90

i **1**
Weitere Informationen

- ideal geeignet zum Reinigen von engen Röhren, Schläuchen oder Abflüssen
- doppelseitig verwendbar
- flexibler Edelstahlschaft
- Nylonborsten

3,90 NEU

Ø 16 mm

Ø 22 mm

150.1762 Flexible Reinigungsbürste

i **7**
Weitere Informationen

Ø 0 - 38 mm

Ø 0 - 48,5 mm

Ø 0 - 65 mm

Ø 0 - 30 mm

Ø 0 - 45 mm

Ø 0 - 45 mm

Ø 0 - 60 mm

79,90

115.1055 KFZ Schlauchschellenzangen-Satz

i **3**
Weitere Informationen

9,90

Ø 15 mm Ø 30 mm Ø 60 mm

150 mm 180 mm 250 mm

115.5050

i **3**
Weitere Informationen

Ø 35 mm Ø 15 mm Ø 23 mm

155 mm 255 mm 165 mm

115.5055

12,90

i **1**
Weitere Informationen

14,90

Absaug- und Füllhandpumpe

150.9221

i **1**
Weitere Informationen

19,90

100 mm

3/8" Spezial-Steckschlüssel für Saugrohr-Verschraubungen

150.2519

i **1**
Weitere Informationen

19,90

12V 5A 60W
Richtung Direction
150.2620

Elektrische Öl-Absaug- und Umfüllpumpe

150.2620

i **1**
Weitere Informationen

Wechselsnuss für 30-45 mm und 60-80 mm Schlauchschellen

4,90

NEU

30 mm

2 in 1 Spezial-Steckschlüssel für Schlauchschellen mit 3-Punkt-Profil

115.0915

i **1**
Weitere Informationen

12,90

NEU

1/2"

108 mm

Kühlerdeckel-Lösewerkzeug für VAG

150.1919





25

Weitere Informationen







0 - 2,5 bar



max. 76 cm



0 - 200 °C
0 - 400 °F



1600 mm



| | | | | | | |
|--------------|--------------|---------|---------|-----------|-----------|---------|
| R123 R124 | R123 R125 | #1 | #2 | #3 | M50 x 2,5 | M42 x 3 |
| M58 x 3 | M62 x 3 | M48 x 4 | M45 x 3 | M50 x 2,5 | M60 x 4 | M52 x 3 |
| M48 x 2,5 | M42 x 2,5 | M50 x 3 | M46 x 3 | M34 x 2,5 | 75 mm | |



179,⁹⁰

MASTER
Kühlsystem-Diagnose-Service-Satz

150.1930





1

Weitere Informationen

Kupplung 7,2 mm auf 4,4 mm



7,2 mm

80 mm

4,4 mm



19,⁹⁰

NEU

150.1936





1

Weitere Informationen

Kupplung 4,4 mm auf 7,2 mm



4,4 mm

74 mm

7,2 mm



24,⁹⁰

NEU

150.1937

i **8**
Weitere Informationen

250 ml

99,90

OPTIONAL ZUM NACHKAUF

14,90

150.1914

150.1910 CO2-Zylinderkopf-Lecktest-Satz

i **3**
Weitere Informationen

GENIAL FLEXIBEL

53 x 29,5 x 3,2 cm

1

2 **25,5 x 23,3 x 2,4 cm**

3 **27,5 x 14,5 x 2,4 cm**

NEU

44,90

500.8077 Werkzeugablagensatz aus Silikon

i 2
Weitere Informationen

Ford EcoBoost

NEU

180 mm + 215 mm

14 mm + 16 mm

24,90

FÜR FORD ECOBOOST MOTOREN 1,0 LITER

FÜR FORD ECOBOOST MOTOREN 1,5 LITER



517.1135 **Zündkerzen-Stecknuss-Satz für EcoBoost Motoren**

i 2
Weitere Informationen

M20 x 1.5 + M22 x 1.5

27 mm

13 mm

- zum Nachschneiden verrosteter und beschädigter Sondengewinde
- ideal für NOX- und Partikelfiltersensoren an Abgasanlagen
- mit 6 Schneiden für ideale Zentrierung
- besonders kurze Ausführung
- mit Reinigungsnuten im Führungsbolzen

mit 6 Schneiden für ideale Zentrierung

mit Reinigungsnuten im Führungsbolzen

179,90

150.2540 **Gewindeschneider-Satz mit Führungsbolzen für Sensoren**



GENIALE PROBLEMLÖSER

NEU

i 1
Weitere Informationen

Gewindeschneider mit Führungsbolzen

- zum Nachschneiden verrosteter und beschädigter Sondengewinde

13 mm

mit 6 Schneiden für ideale Zentrierung

mit Reinigungsnuten im Führungsbolzen

99,90

| | | | L1 | L2 | | | |
|----------|----------|----------------------------|------------|-------|-------|-------|---------|
| A | 150.2541 | für Temperatursensoren | M12 x 1,25 | 55 mm | 33 mm | 13 mm | 99,90 € |
| B | 150.2542 | für Temperatursensoren | M14 x 1,5 | 45 mm | 30 mm | 13 mm | 99,90 € |
| C | 150.2543 | für Lambdasonden | M18 x 1,5 | 42 mm | 27 mm | 13 mm | 99,90 € |
| D | 150.2544 | für NOX-Sensoren | M20 x 1,5 | 50 mm | 27 mm | 13 mm | 99,90 € |
| E | 150.2546 | für Partikelfiltersensoren | M22 x 1,5 | 50 mm | 27 mm | 13 mm | 99,90 € |



i  **1**
 Weitere Informationen

19,90



1 **2**

500.7505 Zündspulen-Abzieher für Stab-Zündspulen



i  **7**
 Weitere Informationen

FÜR VAG UND OPEL MOTOREN

69,90



1 **2** **3** **4** **5** **6** **7**

500.7570 T-Griff-Zündspulen-Abzieher-Satz für VAG und Opel Motoren



i  **7**
 Weitere Informationen

120 ml 120 ml



6x10
6x6
6x8
6x4
600 mm
Ø 6x9 mm

169,90

150.1900 Druck- und Unterdruck-pumpen-Satz



i  **24**
 Weitere Informationen



49,90

700.1280 Universal Wellendichtung und Simerring Montagewerkzeug-Satz



i **1**
Weitere Informationen

max. 165 mm

39,90

M 12 x 75 mm

30 mm

40-165 mm

3/8" 17 mm

Universal-Rillen-Riemenscheiben-Abzieher Ø 40-165 mm

150.3170

i **1**
Weitere Informationen

NEU

1/4" 13 mm

- zum Spannen und Entspannen der Zahnriemen-Spannrolle
- verstellbar, universal einsetzbar
- Innenvierkantantrieb nach DIN 3120 / ISO 1174
- mit Außensechskantantrieb 13,0 mm
- phosphatiert

Ø 3,0 mm

8 - 25 mm

19,90

Universal-Zapfenschlüssel für Zahnriemen-Spannrolle, verstellbar

150.3046

i **1**
Weitere Informationen

Anwendungsgebiete: Citroën, Peugeot, Opel und Toyota mit 1,0 und 1,2 Benzin-Motoren (Motorcode: ZMZ (EB0F / EB0) / HMO1 (1PP) / HMV, HMZ (EB2) / HMZ (EB2 / EB2F) / HMT (EB2D) / HMU (EB2D) / HNZ (EB2DT) / HNY (EB2DTS) / HMV (EB2M) / HMY (EB2M) / B12XE (EB2F) / D12XE (EB2FA) / B12XHL (EB2DT) / D12XHL, F12XHL (EB2ADT) / B12XHT (EB2DTS) / D12XHT, F12XHT (EB2ADTS))

9,90

Zahnriemen-Prüfwerkzeug für PSA

400.2118

i **1**
Weitere Informationen

M 15 x 1,5 x 71 mm

17 mm

27 mm

70 mm

34,90

Universal-Riemenscheiben-Abzieher 3-armig

150.3130

i **22**
Weitere Informationen

- für die Montage und Demontage der schwer zu öffnenden CLIC-Federverschluß-Leitungskupplungen bei Kraftstoff-, Klimaanlage-, Luft- und Hydraulikleitungen
- keine Beschädigung der Steckkupplungen, Kraftstoffleitungen und Kraftstoffschläuche
- schnelles und einfaches Trennen der Kraftstoffleitungen
- für nahezu alle Leitungskupplungen an europäischen, asiatischen und amerikanischen Fahrzeugen

115.1260 Leitungverbinder-Entrieglungs-Satz

49,90

5/16" 1/4" 5/16" 3/8" 3/8" 1/2" 5/8" 7/8"

3/8" 1/2" 5/8" 3/4" 5/16"

3/8" 1/2" 5/8"

3/4" 7/8" 5/16" x 3/8"

5/16"



Weitere Informationen

MIT 3.873 SCHLÄGEN PRO MINUTE ZIEHT ER JEDEN AUS!

- inklusive 7 Adaptern für nahezu alle Injektoren
- enorm hohe Schlagwirkung (3365 (6,3 bar) / 3873 (8 bar) Schläge pro Minute)
- zum Ausbau der festgebrannten Injektoren im Zylinderkopf
- mit einem entsprechenden Adapter wird der Auszieher an der feststehenden Einspritzdüse verschraubt
- geringer Platzbedarf durch kompakte Bauweise



| | | |
|------------------|------------|-----------|
| 223 L/min | 3/4"-19 mm | 108,4 dbA |
| 6,3 bar (90 psi) | 71,9 m/s² | 6 mm |
| 12 bar | 119,4 dbA | M18 x 1,5 |



| | | |
|----------|---------------|--------------------------------------|
| A | M25 x 1,0 | Siemens |
| B | M20 x 1,0 | Denso |
| C | M27 x 1,0 | Siemens |
| D | M27/M17/10 mm | Bosch/Fiat/BMW/PSA/ Mercedes/Renault |
| E | M18 x 1,5 | Adapter |
| F | M17 x 1,0 | Bosch/Mercedes |
| G | M16 x 1,0 | Toyota |
| H | M14 x 1,5 | Bosch/Delphi/BMW |



BOSCH ✓
DENSO ✓
DELPHI ✓
SIEMENS ✓
 ... ✓

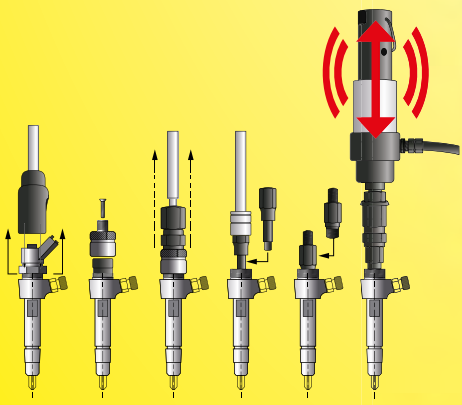

269,90

152.1130 Druckluft Injektoren-Auszieher-Satz

Alle Preise in EUR zzgl. MwSt. gelten bis 30.09.2024

6
Weitere Informationen

285 - 875 mm
TELESKOPIERBAR
150 - 675 mm

500g
200g
1000g
2000g
3000g

Ø 4 mm
Ø 13 mm
Ø 16 mm
Ø 19 mm

400 mm
510 mm

NEU

26,90

550.1090 **Flexibler und teleskopierbarer Magnethalter und Inspektionsspiegel-Satz**

1
Weitere Informationen

125 mm

6 - 24 V
4,90

550.1504 **Prüflampe 6 - 24 V**

1
Weitere Informationen

11,90

3 - 48 V

550.1503 **Polaritäts- und Spannungsprüfer 3 - 48 V**

2
Weitere Informationen

129,90

25 m

6 - 24 V

150.1655 **Funktionsprüflampe**

2
Weitere Informationen

1 Empfänger
2 Sender mit Krokodilklemmen

59,90

150.3075 **Gleichstrom-Kurzschlussdetektor**





Weitere Informationen





369,⁹⁰



Batterie laden

Erhaltungsladen

Reparatur der Batterie

Gleichstromversorgung

umschaltbar zwischen 12 und 24 Volt

Temperatursensor



550.1745 12V + 24V SMARTcharger Hochfrequenz-Batterieladegerät 25A/12,5A

Technische Daten:

| | |
|--------------------|---|
| Batteriekapazität: | 12V: 75-500Ah - 24V: 45-250Ah |
| Spannungsbereich: | 220-240V AC, 50/60HZ |
| Ladespannung: | 14,4V - 25A (12V), 28,8V - 12,5A (24V) |
| Frequenzbereich: | 50 Hz |
| Leitung: | H05RN-F 2x1,0 mm ² |







Weitere Informationen





367,⁹⁰





Für fast alle Batterien

Mit Drucker und 3 Rollen Papier

550.1649 12V / 24V Digital-Batterie- und Ladesystemtester mit integriertem Drucker

Technische Daten:

| | |
|--------------------------|-----------------|
| Anzeige: | digital |
| Arbeitsbereich CA / MCA: | 40-2.000 CCA |
| Arbeitsbereich CCA: | 40-2.000 CCA |
| Arbeitsbereich DIN: | 40-2.000 CCA |
| Arbeitsbereich EN: | 40-2.000 CCA |
| Arbeitsbereich IEC: | 40-2.000 CCA |
| Arbeitsbereich JIS#: | 40-2.000 CCA |
| Arbeitsbereich SAE: | 40-2.000 CCA |
| Arbeitstemperatur: | 0°C bis +55°C |
| Frequenzbereich: | 100 Hz |
| Messbereich: | 9-36 V |
| Messgenauigkeit: | +/- 0,5 Megaohm |
| Spannungsbereich: | 9-36 V |



MF WET AGM VRLA GEL ✓





Weitere Informationen





599,⁹⁰





550.1720 12V + 24V Batterie-Booster - mobiles Starthilfegerät 1400 A

1.400 A

Intelligentes Sicherheitskonzept vermeidet Anwender-Fehler:

Sicherheits-schaltung gibt erst Strom auf die Klemmen wenn:

- korrekt angeschlossen wurde (Polung)
- die Verbindung kurzschluss-sicher ist
- die richtige Spannung anliegt
- die Fahrzeugbatterie in Ordnung ist



i **26**
Weitere Informationen

DVE **GS**
1000 V

3/8"

329,90

Werkzeugsatz mit isolierten Werkzeugen für Hybrid- und Elektrofahrzeuge

117.1895

| | | |
|------|--|---|
| 2 x | | 4 mm - 5,5 mm |
| 2 x | | PH1 - PH2 |
| 6 x | | 6 - 8 - 10 - 12 - 13 - 17 mm |
| 1 x | | 185 mm |
| 1 x | | 165 mm |
| 1 x | | 3/8" |
| 1 x | | 3/8": 200 mm |
| 1 x | | 3/8": 125 mm |
| 10 x | | 3/8": 8 - 10 - 11 - 12 - 13 - 14 - 16 - 17 - 19 - 22 mm |
| 1 x | | 200 mm |

i **43**
Weitere Informationen

DVE **GS**
1000 V

3/8"

564,90

Isolierter Werkzeug-Satz für Hybrid- und Elektrofahrzeuge

117.1890

| | | |
|------|--|---|
| 4 x | | 2,5 - 3 - 3,5 - 4 mm |
| 3 x | | PH1 - PH2 - PH3 |
| 3 x | | T20 - T25 - T30 |
| 1 x | | 210 mm |
| 1 x | | 185 mm |
| 1 x | | 165 mm |
| 1 x | | 215 mm |
| 1 x | | 165 mm |
| 1 x | | 240 mm |
| 2 x | | 10 - 25 mm |
| 1 x | | 180 mm |
| 1 x | | 3/8" |
| 15 x | | 3/8": 6 - 7 - 8 - 9 - 10 - 11 - 12 - 13 - 14 - 16 - 17 - 18 - 19 - 20 - 22 mm |
| 2 x | | 3/8": 150 - 250 mm |
| 3 x | | 3/8": M8 - M10 - M12 |
| 1 x | | Ø 200 mm |
| 1 x | | 200 mm |
| 1 x | | 500 m |

i **18**
Weitere Informationen

DVE **GS**
1000 V

329,90

Maulschlüssel-Satz mit Schutzisolierung

118.1500

| | | |
|------|--|---|
| 18 x | | 7 - 8 - 9 - 10 - 11 - 12 - 13 - 14 - 15 - 16 - 17 - 18 - 19 - 20 - 21 - 22 - 23 - 24 mm |
|------|--|---|

i **1**
Weitere Informationen

<44.500 V

179,90

Isolierte Rettungsstange

150.0913

1.680 mm

DER EINSTEIGER-SATZ IN DIE ELEKTROMOBILITÄT

ecoLine



1

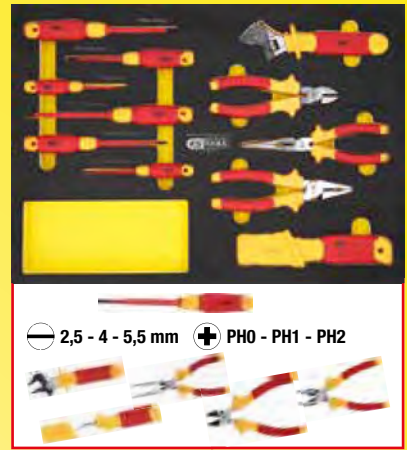

2

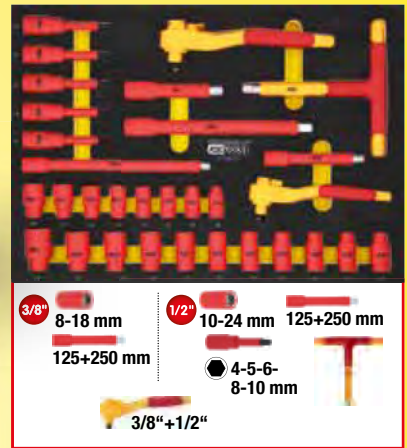

Vierkantlochung für Zubehörteile

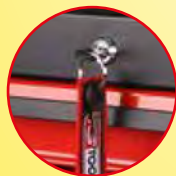

verschießbar durch eingebautes Zylinderschloss



Arbeitsplatte mit 10 mm starker Schaumstoffeinlage



mit Selbsteinzug und SOFT-CLOSE-Funktion



2 x Roll- und Drehbremsen Ø Räder: 125 mm

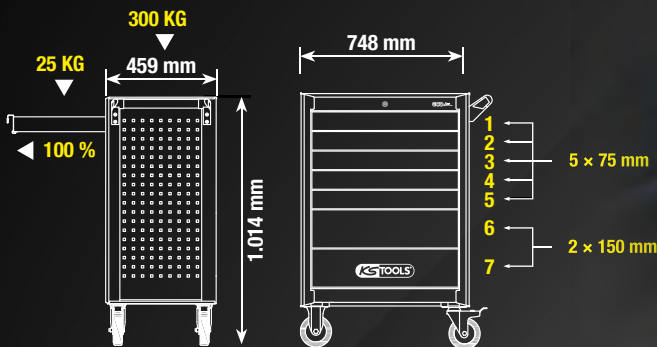

1299,00 

INKLUSIVE 42 WERKZEUGE

ECOline Werkstattwagen mit 42 isolierten Werkzeugen für Hybrid- und Elektrofahrzeuge

117.6144



4299,00



117.6172 3/8"+1/2" Isolierter Steckschlüssel-Satz mit Drehmomentschlüssel in Schaumstoffeinlage, 72-tlg



117.6133 Isolierte Schlüssel-Satz in Schaumstoffeinlage, 33-tlg

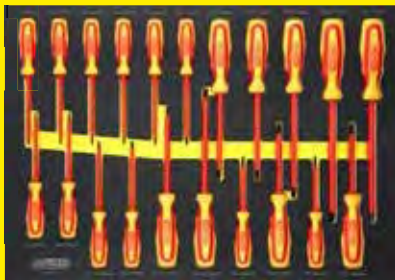

117.6121 ERGOTORQUE VDE Schraubendreher-Satz in Schaumstoffeinlage, 21-tlg



117.6117 ERGOTORQUE VDE Zangen-Satz in Schaumstoffeinlage, 17-tlg



117.6155 PERFORMANCEplus Werkstattwagen e10 mit 164 isolierten Werkzeugen für Hybrid- und Elektrofahrzeuge

DER UMFANGREICHSTE SEINER KLASSE

9,90



117.0223 Dachaufsteller mit Blitzsymbol und Magnet



9,90

117.0222

Dachaufsteller mit Blitzsymbol und Saugnapf



14,90

117.0226

Aufsteller mit Blitzsymbol

69,90

117.1550

Absperrpfosten-Satz mit Kette

2x

139,90

117.1545
2 x Scherensperre aus Kunststoff



Den Elektromobilitäts-Katalog mit 188 Seiten finden Sie unter www.kstools.com



i  **4**
Weitere Informationen

Ø 22,0 - 28,0 mm

Ø 15,0 - 21,0 mm

Ø 17,0 - 25,0 mm

Kupplungs-Zentrier-Werkzeug-Satz

8,90

150.2180 Ø 15,0 - 28,0 mm



i  **11**
Weitere Informationen

150 kg

310 mm

450 mm

300 mm

394,90

160.0910 **Universal-Getriebehalter-Satz**



i  **3**
Weitere Informationen

- 1 Füllwerkzeug A montieren und demontieren
- 2 Öl ablassen, geringer Durchfluss
- 3 Füllstand überprüfen
- 4 Öl ablassen, voller Durchfluss

24,90

9G-TRONIC

56 mm

20 mm

74,5 mm

9 mm

26,5 mm

39,5 mm

9 mm

152 mm

48 mm

150.9695



160.0910 **Universal-Getriebehalter-Satz**



i  **24**
Weitere Informationen

DER UMFANGREICHSTE!

| | | |
|----------|---|--|
| 150.9261 |  | 1/8-27 NPT Ford |
| 150.9262 |  | BMW, Honda, Nissan etc. |
| 150.9263 |  | VAG |
| 150.9264 |  | VAG, Porsche |
| 150.9265 |  | M10 x 1.0 VAG, Mini Cooper |
| 150.9267 |  | M12 x 1.5 Mercedes |
| 150.9268 |  | M24 x 1.5 VAG DSG |
| 150.9269 |  | M22 x 1.5 VAG CVT |
| 150.9271 |  | M18 x 1.5 Skoda |
| 150.9272 |  | M30 x 1.5 VAG, Skoda |
| 150.9273 |  | Universal Flexible 300 mm, Honda, Hyundai, Kia, etc. |
| 150.9274 |  | 5/16-24 (UNF) Volvo |
| 150.9276 |  | M18 x 1,5 Toyota / Lexus |
| 150.9277 |  | M8 x 1,0 Nissan / Infinity |
| 150.9278 |  | ATF-Adapter V.W, Passat |
| 150.9562 |  | Nissan Juke M12 x 1,25 |
| 150.9563 |  | Mini Cooper M14 x 1,5 |
| 150.9564 |  | issan M10 x 1,5 |
| 150.9566 |  | GM M12 x 1,75 |
| 150.9567 |  | Mercedes 725-9G |
| 150.9102 |  | VAG 7 DSG |
| 150.9103 |  | VAG 7 DSG |
| 150.9104 |  | VAG 7 DSG |

199,90

INKLUSIVE 23-TLG ADAPTERSATZ

NEU!

150.9105 **Universal Getriebeöl-Füllsystem-Satz inkl. 23-tlg Adaptersatz**



i  **4**
 Weitere Informationen



111,90

Ø 30 mm

McPherson Federbeinstütze für Getriebeheber

160.0195

i  **7**
 Weitere Informationen



6 mm

99,90

Spezial Stoßdämpfer-Montagehilfe-Satz für Stoßdämpfer mit Zuganschlagfeder

150.9545





FÜR IHRE SICHERHEIT  **GEPRÜFT!**

i  **6**
 Weitere Informationen

universal für 90% aller gängigen Fahrzeugfedern im PKW und Transporterbereich



Ø 80 - 160 mm

Ø 140 - 195 mm

BELASTUNG max 26000 N

451,90

Universal Federspanner-Satz

500.8400

- ideal geeignet zur sicheren Montage und Demontage von Mc Pherson Federbeinen
- erforderlich beim Stoßdämpfer- oder Schraubenfederwechsel
- universal für 90% aller gängigen Fahrzeugfedern im PKW und Transporterbereich
- kostengünstige und solide Alternative zu gängigen Federspanner
- auch für konische - und Kugelfedern geeignet
- mit TÜV-Zulassung

| Technische Daten: | |
|-------------------|-----------------|
| Federdruck max.: | 2600 kg |
| Spannweite max.: | 355,0 |
| Federkapazität: | 80,0 - 195,0 mm |

FÜR IHRE SICHERHEIT



GEPRÜFT!

i **11**
Weitere Informationen

TUV SUD

1/2" x 1/2", 100 Nm

Ø 30 mm

Ø 90 - 140 mm

372,⁹⁰

500.8765 Audi und Seat Teleskop-Centerspanner-Satz für innenliegende Federn

ZUR ERWEITERUNG

i **2**
Weitere Informationen

Ø 95-110 mm

FÜR FEDERSPANNER
500.8755 + 500.8765

99,⁹⁰

500.8770 Paar-Federhalter Ø 95-110 mm

Anwendungsgebiete:
Mercedes E-Klasse (W211 / W212), C-Klasse (W204), GLA (X156), GLK (X204),
Ford Focus II (MK2), BMW 1er (E81), Volkswagen Passat (B8 / 3G)

ZUR ERWEITERUNG

i **9**
Weitere Informationen

TUV SUD

Ø 30 mm

Ø 90 - 140 mm

Ø 75 - 115 mm

WARNING - ACHTUNG - ADVARSEL
ADVERTENCIA - AVERTISSEMENT

338,⁹⁰

500.8755 Universal Teleskop-Centerspanner-Satz für innenliegende Federn

FÜR 95% ALLER FAHRZEUGE



Weitere Informationen

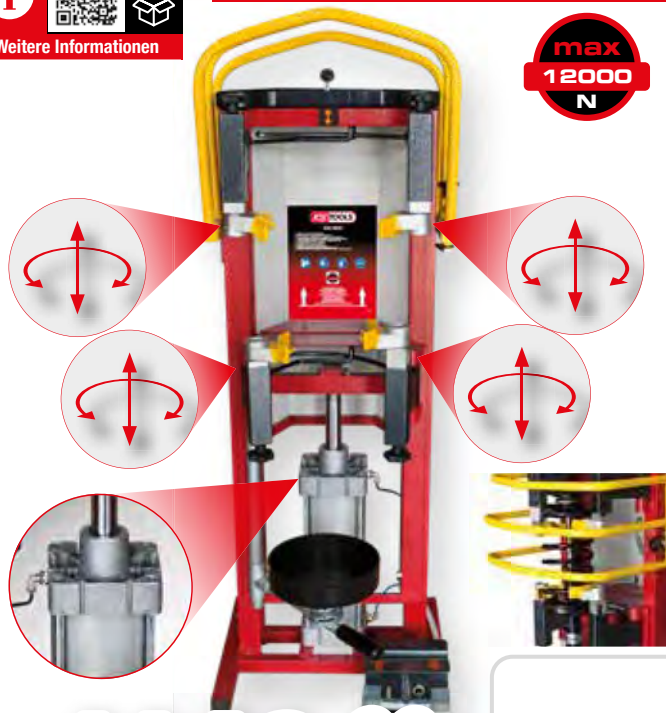

max
12000
N

1149,00

Druckluft-Stand-Federspanner,
max. 10 bar

500.8800



Weitere Informationen



max
24000
N

1599,00

Druckluft-Stand-Federspanner
mit Doppel-Zylinder

500.8810



Weitere Informationen

- einfache Handhabung
- Spezial-Werkzeugstahl
- ideal zur Aufnahme von Federbeinen
- optimal für sicheren Stand bei der Montage und Demontage
- mit 4 Fixierbolzen und 4 Gewindebolzen
- Lieferung erfolgt mit 2 Sprengringen zur Montage

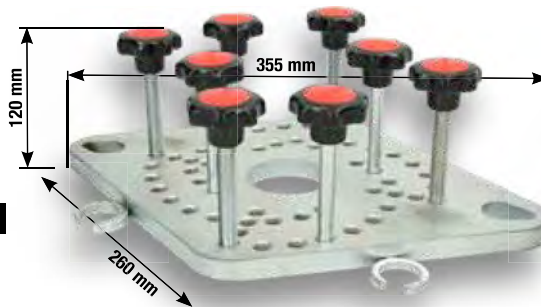

281,90



500.8801

Adapterplatte für Druckluft-Stand-Federspanner

FEDERSPANNER-SATZ INKLUSIVE ADAPTERPLATTE



Weitere Informationen

Druckluft-Stand-Federspanner
inkl. Adapterplatte

1349,00

500.8805



Weitere Informationen

Druckluft-Stand-Federspanner
mit Doppel-Zylinder
inkl. Adapterplatte

1799,00

500.8815

KONFIGURIEREN SIE NACH IHREN WÜNSCHEN



440.9051



1199,⁹⁰

568 mm
XL
1429 mm

GRÖßER
ALS
MAN
DENKT

BREMSE



440.9087



2499,⁹⁰

SILENTLAGER



440.9025

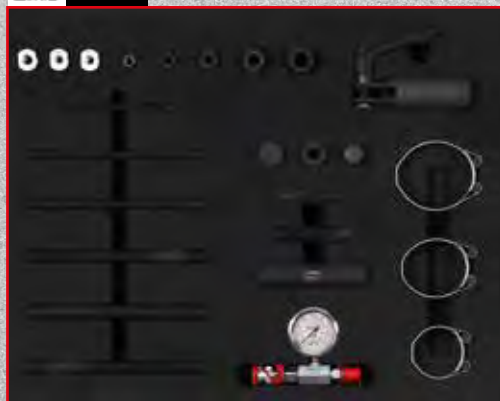

**HYDRAULIKZYLINDER OHNE
BETÄTIGUNGSWERKZEUGE**



440.9161



3399,⁹⁰

KOMPAKT-RADLAGER



440.9026

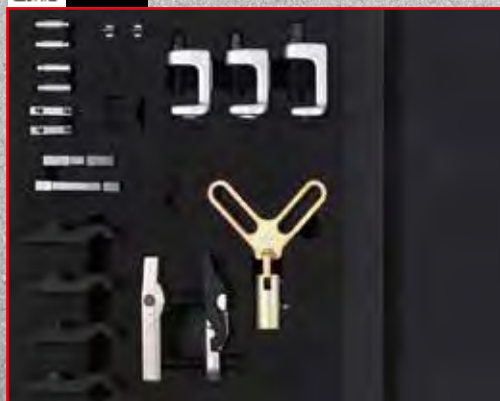

ACHSE



HALBE LEBEN

MODULO 2



873.6008

PERFORMANCEplus P40 SCHWARZ/ROT
Werkstattwagen mit 4 Schubladen

2760,50

OHNE WERKZEUGE



Weitere Informationen







899,90

Hydraulik-Pumpen-Satz
mit Ablage für P40

440.9004



999,90



440.9076



1999,90



RADLAGER



799,90



440.9061



1899,90



STOSSDÄMPFER



i 1
Weitere Informationen

99,90

max. 8 bar

450 mm

1/4" PT

für Universal Achsmanschetten

515.3100 Druckluftmontagegerät für Achsmanschetten

i 1
Weitere Informationen

100 mm

255 mm

Ø 30 mm

49,90

150.1850 Universal Gelenkwellen-Abzieher

i 1
Weitere Informationen

0 - 45 mm

270 mm

39,90

115.1056 Schlauchklemmzange für Drehmomentanzug

i 1
Weitere Informationen

max. 12 mm

49,90

115.1590 Spannzange für Edelstahl-Kabelbinder mit Kugerverschluss

ab 25,90

Edelstahl-Kabelbinder mit Kugerverschluss

200 - 350 mm

| | | | | |
|----------|--|-----|--------------|---------|
| 115.1591 | | 100 | 4,6 × 200 mm | 25,90 € |
| 115.1592 | | 100 | 4,6 × 250 mm | 25,90 € |
| 115.1593 | | 100 | 4,6 × 350 mm | 28,90 € |
| 115.1594 | | 100 | 4,6 × 500 mm | 37,90 € |

i 1
Weitere Informationen

UNIVERSAL

10 mm

39,90

700.5662 Klemmbohrungs-Spreizwerkzeug

i **1**
 Weitere Informationen

24,90

Spezial Tragelenkstecknuss für Mercedes

150.1721 Mercedes W167, W205, W213, W238, W253, W25

i **6**
 Weitere Informationen

369,90

Vibro-Impact Druckluft-Meißelhammer-Satz

515.3880

- 110 mm
- 110 mm
- 130 mm
- 100 x 25 x 12 mm

10 mm

10 mm

10 mm

10 mm

15280316

VIBRO-POWER

515.3881

31 x 1 sec.

VIPRO

i **3**
 Weitere Informationen

31,90

**Klemmschrauben-
Austreiber-Satz**

700.5635

10 mm

i **1**
 Weitere Informationen

159,90

Vibro-Impact Lösewerkzeug für Spurstangen

150.1608

- vibrationsunterstütztes Lösen von Spurstangen, Konterverschraubungen oder Verschraubungen im Achsenbereich etc.
- durch den speziellen Vibrationsdorn wird ein Schlagimpuls auf die zu lösende Verschraubung gegeben, dabei werden Anrostungen gelöst und der Lösevorgang unterstützt
- Druckluft-Meißeladapter (10 mm) für den Einsatz mit marktüblichen Druckluft-Meißel-Schlaghammer

27 mm

290 mm

10 mm

65 mm



Weitere Informationen



168,90

700.1495 Universal-Achsheber mit Kette



- durch flexible Kette lassen sich Querlenker unterschiedlichster Bauformen ohne großen Kraftaufwand sicher niederdrücken



Weitere Informationen

121,90

- stabile Trapez-Gewindespindel
- Fußpedal zur Feinjustierung (20mm)
- der ideale Werkstatthelfer in vielen Situationen



160.0342 Teleskop-Unterstellstütze



Weitere Informationen



89,90

911.6187 Teleskop Gelenk-Rollkopf-Hebeleisen



Weitere Informationen

99,90



700.1465 Achsspielprüfer



Weitere Informationen

MIT SCHNELLVERRIEGELUNG



451,90

1000 W

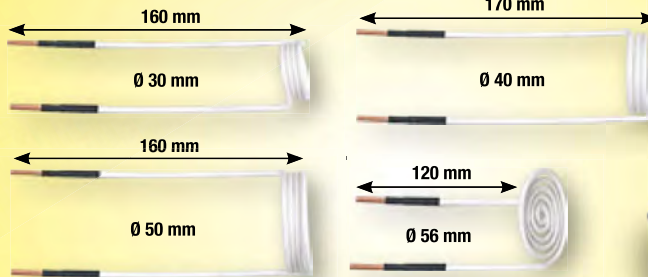

500.8605 Induktions-Heizpistolen-Satz



OPTIONAL ZUM NACHKAUF



129,90

500.8440

2. GENERATION - 2. GENERATION - 2. GENERATION - 2. GENERATION



Weitere Informationen

HAKEN DRAN!

NEU 14,90

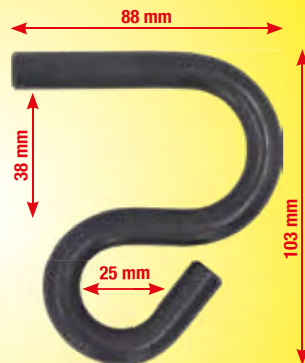
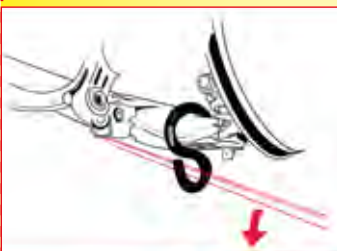

spezielle Form ermöglicht diesen sehr nah am Tragelenk anzusetzen

spezieller Hebel für die fachgerechte und schonende Montage und Demontage von Achsteilen

Universal-Achshebel-Haken

700.1499



Weitere Informationen



299,90

700.1550 Druck- und Zughülsen-Satz



i **22**
Weitere Informationen

42 40 38 36 34
32 30 28 26 24
#1
#2
#3
#4
M12
M10
M12 M10 TR20

700.2355 Stufen-Druckhülsen-Satz

499,90



i **4**
Weitere Informationen

79,90

30-35 mm 35-40 mm 40-45 mm
360 mm
1/2" / 32 mm

150.1125 Axialgelenk-Spezialschlüssel-Satz



i **2**
Weitere Informationen

M12

NEU

115 mm 72 mm

19,90

Spezial-Kraft-Bit-Stecknuss-Satz für Vielzahn(XZN®)-Schrauben

515.0595 1/2"

i **30**
Weitere Informationen

1 x $\emptyset 90 - 130 \text{ mm}$
1 x 4 x M14
4 x M12 x 1,25
M12 x 1,5
M12 x 1,25
M12 x 1,5
M14 x 1,5
1 x M18 x 2,5 x 230 mm M57 x 2

4,3 Kg

224,90

700.1530 Universal-Radnaben- und Gelenkwellen-Abzieher-Satz

WENIGER PERSONALEINSATZ, MEHR GEWINN.

SCHEIBE AUSTRENNEN OHNE HELFER!

140.2630

Universal Ein-Mann-Betrieb-Scheiben-Austrenngerät

- ideal für den fachgerechten und schonenden Ausbau von geklebten Windschutzscheiben sowie den meisten Heck- und Seitenscheiben
- mit großer Umlenkrolle, dadurch geringerer Kraftaufwand und Minimierung der Gefahr von Drahtriss
- Drahtführung unmittelbar vor der Scheibe, dadurch entfällt in den meisten Fällen die aufwendige Demontage von Verkleidungsteilen
- leichte Bedienung durch Einmannbetrieb
- besonders hochwertige Pumpsauger für sicheren Halt auf der Scheibe



Weitere Informationen



ONE MAN CUT



Profi-Schutztafel-Satz, 4-tlg
2x 270x200 mm + 2x 450x300 mm

Schneiddrahtfixierung

Hochwertiger Pumpsauger

6-Kant-Antrieb, 30 mm

Nylon, 50 m

Umlenkrolle

Saugteller Ø 50 mm

Saugteller Ø 50 mm

Schneiddrahtfixierung

Saugkraft: 110 kg

4-kant-Draht, 50 m

Entlastungshebel

Saugkraft: 110 kg

Schneiddraht-Einführsonde, 290 mm

Umlenkrolle

Saugkraft: 110 kg

Saugteller Ø 150 mm

Schutztafel, abgewinkelt

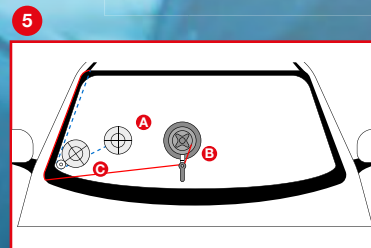
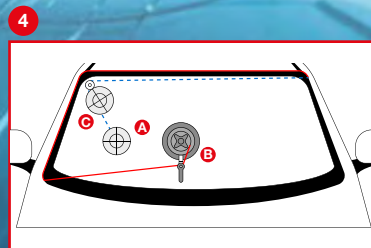
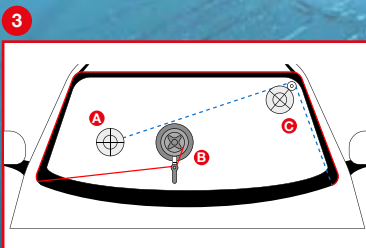
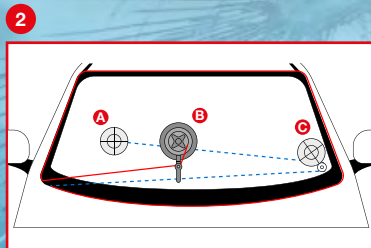
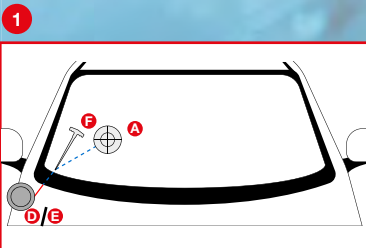

599,90

Inklusive



NEU

1
Weitere Informationen

AUCH FÜR DOT5.1, ENV4 UND ENV6

- Dot3 ✓
- Dot4 ✓

0 20 mm

155 mm

14,90

150.1969 Bremsflüssigkeitstester

1
Weitere Informationen

VITON®
EKM

27,90

150.8258 Pumpsprühflasche

Speziell für Bremsenreiniger

2
Weitere Informationen

10,90

150.1935 Universal-Haken-Satz, formbar

2
Weitere Informationen

14,90

150.2235 Universal-Haken-Satz, starr

12
Weitere Informationen

49,90

Bremssattelverschraubung-Spezialstecknuss-Satz

150.2400

1/2" 11,5 mm 14 mm 15 mm 20 mm AS 22 mm

1/4" 9 x 20 mm

3/8" 7 x 72 mm
7 x 92 mm
9 x 50 mm
11 x 100 mm

3/8" 7 x 25 - 8 x 25 mm

41
Weitere Informationen

99,90

Bremskolben-Rückstell-Werkzeug-Satz

150.1970



Weitere Informationen

DAS UNIVERSAL-GENIE



UNIVERSAL
Für 95% aller Fahrzeuge

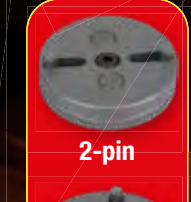
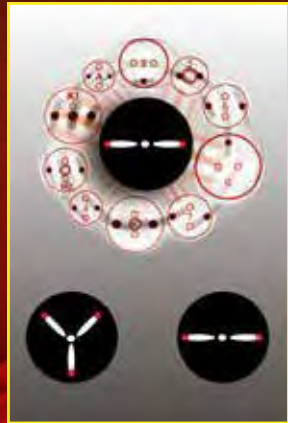

2-pin



3-pin



3/8"



4-pin



129,90



150.2440 Universal Bremskolben-Rückstell-Werkzeug-Satz



Weitere Informationen

699,90



5L

160.0700 Bremsenwartungsgerät KS5

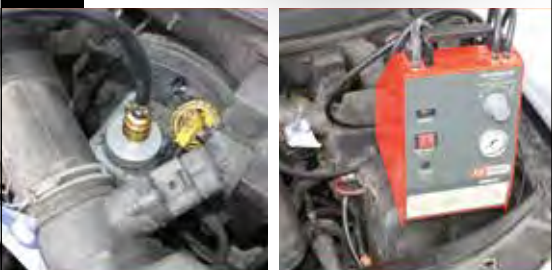

Weitere Informationen

49,90



360°

min. 18 mm

universal verstellbar



Max. 70 mm

Min. 28 mm

160.0718 Universal-Entlüfterstutzen-Adapter, verstellbar



Weitere Informationen

TOYOTA & LEXUS

NEU

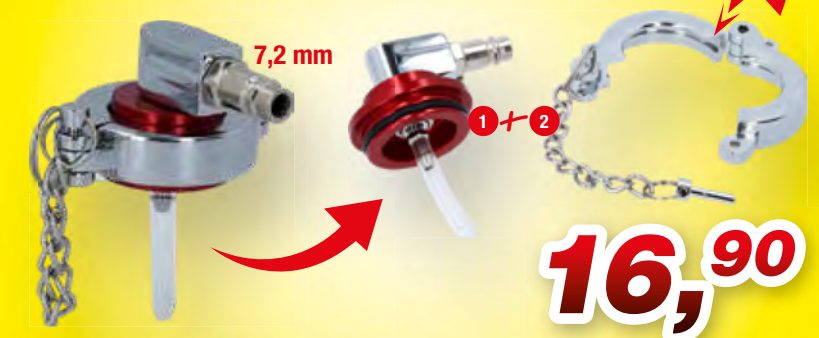

7,2 mm

1+2

16,90

160.0719 Universal-Entlüfterstutzen-Adapter für Toyota und Lexus

i **6**
Weitere Informationen

1.200 mm

STOP

11 mm
10 mm
9 mm
8 mm
7 mm

69,90

160.0725 Bremsen-Entlüftungsschlüssel-Satz

i **11**
Weitere Informationen

DER KOMPLETTE

1.200 mm

STOP

9x12 mm 180 mm

11 mm 10 mm 11 mm 7 mm 11 mm 10 mm 11 mm 85 mm

NEU

74,90

518.0320 Bremsen-Entlüftungs-Werkzeug-Satz für VAG

i **1**
Weitere Informationen

4,75 mm (3/16") 21 mm 31 mm 41 mm 61 mm 76 mm

39,90

120.1006 Bremsleitungs-Biegewerkzeug

i **1**
Weitere Informationen

4,75 mm (3/16") 6,35 mm (1/4")

29,90

120.1004 Bremsleitungs-Richtwerkzeug / -Biegewerkzeug

① Biegen
② Duplizieren
③ Richten

OUT IN

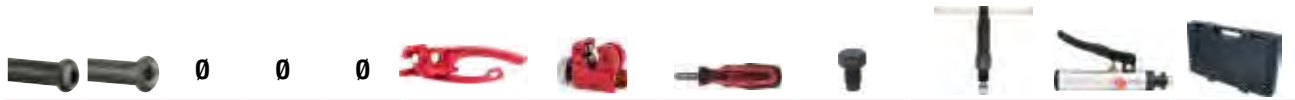

| | | DIN | SAE | 4,75 mm | 5,0 mm | 6,0 mm | mit Rohrbieger | mit Rohrschneider | mit Rohrentgrater | mechanisch | mit Hydraulikspindel | Handpumpe | im Koffer |
|---|----------|-----|-----|---------|--------|--------|----------------|-------------------|-------------------|------------|----------------------|-----------|-----------|
| 1 | 122.1215 | ✓ | ✗ | ✓ | ✗ | ✗ | ✗ | ✗ | ✗ | ✓ | ✗ | ✗ | ✗ |
| 2 | 122.1290 | ✓ | ✓ | ✓ | ✓ | ✓ | ✓ | ✓ | ✓ | ✗ | ✓ | ✗ | ✓ |
| 3 | 122.1260 | ✓ | ✓ | ✓ | ✓ | ✓ | ✗ | ✗ | ✗ | ✗ | ✗ | ✓ | ✓ |





4



Weitere Informationen



49,⁹⁰

1

FLAREFIXeco 4,75 mm Universal-Bremsleitungs-Bördelgerät-Satz

122.1215





16

FLAREFIX

Weitere Informationen



169,⁹⁰

2



FLAREFIX 1 Universal-Bremsleitungs-Bördelgerät-Satz mit Hydraulik-Spindel

122.1290

- 4,75-5,0 mm, SAE
- 6,0 mm, SAE
- 4,75-5,0-6,0 mm, SAE-90°
- 4,75-5,0 mm, DIN
- 6,0 mm, DIN
- M12x1,25

- 3,0-12,0 mm
- 3,0-16,0 mm
- 4,75 mm, 3/16"
- 5,0 mm
- 6,0 mm





11

HYDRAULISCH, PRAKTISCH, GUT!

Weitere Informationen

FLAREFIX II

Hydraulic



- M12 x 1,25 mm
- 4,75-5,0 mm, SAE
- 6,0 mm, SAE
- 4,75-5,0-6,0 mm, SAE-90°
- 4,75-5,0 mm, DIN
- 6,0 mm, DIN
- M12x1,25

- 5,0 mm
- 4,75 mm, 3/16"
- 6,0 mm

299,⁹⁰

3

FLAREFIX 2 Universal-Bremsleitungs-Bördelgerät-Satz mit Hydraulik-Zylinder

122.1260



Weitere Informationen



3/8"



1 Ford/PSA



2 BMW



3 VAG



4 Mercedes



5 DAF/MAN



6 GM



7 Ford



8 Ford



9 Ford

24,90

3/8" Öldienst-Spezialprofil-Satz für Kunststoff-Ölablassschrauben, 9-tlg

150.1040



Weitere Informationen



69,90

- Werkzeug zum Planen des Dichtsitze von Ölablassschrauben
- Planen des Dichtsitze sichert einwandfreie Abdichtung im Bereich der Ölablassschraube
- exakte Zentrierung und Ausrichtung zur Dichtfläche
- Satz inklusive Adaption für Original-Ölablassschraube und Übermaß-Reparaturgewindeschraube
- in stabilem Kunststoffkoffer

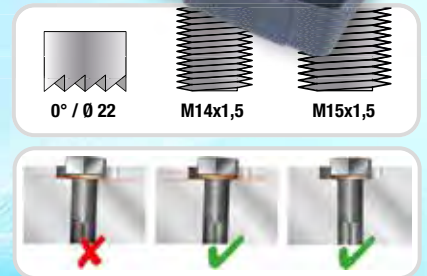

150.1485

Ölablassschrauben-Dichtsitze-Planfräser-Satz



Weitere Informationen



7,5 Liter

Ø 385 mm

12,90

Auffangwanne 7,5 Liter

150.9359



i  **30**
 Weitere Informationen

1/2" 21 mm
 Ø 63 - 102 mm

99,90

3/8"

65-14, 65/67-14, 66-6, 68-14, 73-14, 74-15, 74/76-15, 75/77-15, 76-8, 76-12, 76-14, 76-30, 78-15, 80-15, 80/82-15, 86-18, 86-16, 90-15, 92-10, 93-15, 93-36, 93-45, 95-15, 96-18, 100-15, 106-15, 108-15, 108-18

150.9350 **3/8" Ölfilterschlüssel-Satz**



i  **24**
 Weitere Informationen

2,0 L

99,90

VW Lexus Lotus Ford Nissan
 Subaru Mitsubishi Land Rover Hyundai Audi
 Chrysler Toyota Citroën Volvo Cadillac
 Citroën Buick Volvo Buick universal

150.9130 **MASTER Öl-Einfülltrichter-Satz mit drehbarem Winkelarm**



i  **4**
 Weitere Informationen

FÜR VAG

mit drehbarem Winkelarm für schwer zugängliche Stellen

14,90

2,0 L

150.9155 **Öl-Einfülltrichter-Satz mit drehbarem Winkelarm für VAG**



AUF DIE BÜHNE - FERTIG - LOS!

aus Voll-Gummi



NEU

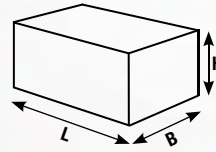

i  **1**
Weitere Informationen

| Teile | L mm | B mm | H mm | | |
|----------|---------|---------|---------|------|---------------------|
| 160.0476 | 1 | 160 | 120 | 20 | 4, ⁹⁰ € |
| 160.0477 | 1 | 160 | 120 | 30 | 6, ⁹⁰ € |
| 160.0478 | 1 | 160 | 120 | 40 | 8, ⁹⁰ € |
| 160.0479 | 1 | 160 | 120 | 60 | 12, ⁹⁰ € |
| 160.0480 | 1 | 160 | 120 | 80 | 16, ⁹⁰ € |
| 160.0481 | 1 | 160 | 120 | 100 | 20, ⁹⁰ € |
| 160.0482 | 1 | 160 | 120 | 115 | 23, ⁹⁰ € |
| 160.0483 | 1 | 116,5 | 116,5 | 36,5 | 5, ⁹⁰ € |
| 160.0499 | 1 | 160 | 120 | 85 | 17, ⁹⁰ € |

PE (Polyethylen)

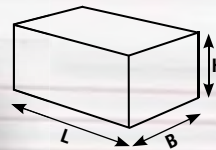
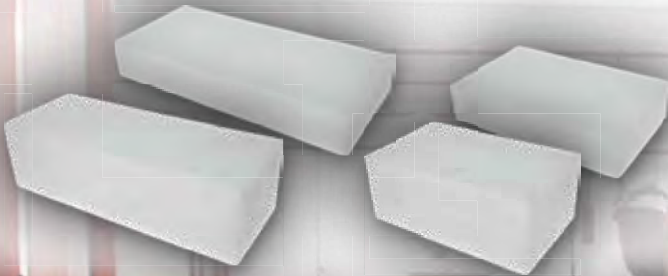

NEU

i  **1**
Weitere Informationen

| Teile | L mm | B mm | H mm | | |
|----------|---------|---------|---------|-----|---------------------|
| 160.0437 | 1 | 250 | 150 | 55 | 14, ⁹⁰ € |
| 160.0438 | 1 | 250 | 150 | 100 | 26, ⁹⁰ € |
| 160.0486 | 1 | 340 | 150 | 55 | 19, ⁹⁰ € |
| 160.0489 | 1 | 340 | 130 | 100 | 31, ⁹⁰ € |

i  **1**
Weitere Informationen

aus Voll-Gummi mit verstärktem Kern



NEU

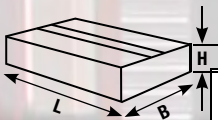

| Teile | L mm | B mm | H mm | | |
|----------|---------|---------|---------|----|---------------------|
| 160.0484 | 1 | 373 | 100 | 35 | 39, ⁹⁰ € |

i  **4**
Weitere Informationen

aus hochfestem Kunststoff



NEU

- Model 3 ✓
- Model S ✓
- Model X ✓
- Model Y ✓



160.0460 Tesla Model 3, S, X, Y

23,⁹⁰

i  **4**
Weitere Informationen

aus Voll-Gummi

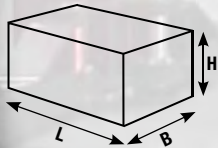

| Teile | L mm | B mm | H mm | | |
|-------------|---------|---------|---------|----|---------------------|
| 160.0391-TD | 4 | 155 | 125 | 35 | 34, ⁹⁰ € |

i  **1**
Weitere Informationen

aus Voll-Gummi



NEU

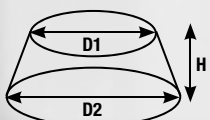

| Teile | D1 mm | D2 mm | H mm | | |
|----------|----------|----------|---------|----|--------------------|
| 160.0485 | 1 | 78 | 105 | 60 | 9, ⁹⁰ € |



aus Gummi und Stahlplatte

Weitere Informationen

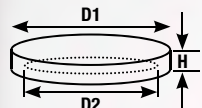

| | D1 mm | D2 mm | H mm | Ravaglioli | Grazia | OMCN | Intertech | MAHA | Werther | Nussbaum | AMI | Twin Bush | Sirio | Space | Launch | RP Tools | J.A. Becker | ATH | HOFMANN | Hermann | | |
|---|----------|----------|---------|------------|--------|------|-----------|------|---------|----------|-----|-----------|-------|-------|--------|----------|-------------|-----|---------|---------|--|--------|
| A | 160.0463 | 120 | 113 | 22 | | | | ✓ | | | | | | | | | | | | | | 8,90 € |
| B | 160.0465 | 123 | 108 | 25 | ✓ | | | | ✓ | | | | | | | | | | | | | 8,90 € |
| C | 160.0475 | 120 | 110 | 19 | | | | | | | | | | | | | ✓ | ✓ | ✓ | ✓ | | 8,90 € |



aus Gummi

Weitere Informationen

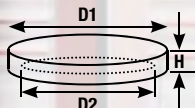

| | D1 mm | D2 mm | H mm | Ravaglioli | Grazia | OMCN | Intertech | MAHA | Werther | Nussbaum | AMI | Twin Bush | Sirio | Space | Launch | RP Tools | J.A. Becker | ATH | HOFMANN | Hermann | | |
|---|----------|----------|---------|------------|--------|------|-----------|------|---------|----------|-----|-----------|-------|-------|--------|----------|-------------|-----|---------|---------|--|---------|
| A | 160.0466 | 125 | 120 | 24 | | | | | | ✓ | ✓ | | | | | | | | | | | 11,90 € |
| B | 160.0467 | 140 | 130 | 25 | | | | | | | | ✓ | | | | | | | | | | 5,90 € |
| C | 160.0468 | 100 | 85 | 14 | ✓ | | | | | | | | ✓ | ✓ | | | | | | | | 4,90 € |
| D | 160.0464 | 120 | 113 | 23 | | | | ✓ | | | | | | | | | | | | | | 4,90 € |
| E | 160.0469 | 120 | 108 | 32 | | | | | | | | ✓ | | | ✓ | ✓ | | | | | | 7,90 € |
| F | 160.0470 | 150 | 130 | 23 | ✓ | | | | | | | | | | | | | | | | | 4,90 € |
| G | 160.0471 | 140 | 125 | 30 | | | | | | | | ✓ | | | | | | | | | | 7,90 € |
| H | 160.0472 | 130 | 125 | 14 | ✓ | | | | | | | | ✓ | ✓ | | | | | | | | 6,90 € |
| I | 160.0473 | 120 | 105 | 30 | | | | | | | | ✓ | | ✓ | | | | | | | | 6,90 € |
| J | 160.0474 | 120 | 110 | 19 | | | | | | | | | | | | | ✓ | ✓ | ✓ | ✓ | | 4,90 € |
| K | 160.0490 | 100 | 80 | 21 | ✓ | | | | | | | | | | | | | | | | | 3,90 € |
| L | 160.0491 | 120 | 108 | 26 | ✓ | ✓ | | | | | | | | | | | | | | | | 4,90 € |
| M | 160.0492 | 120 | 110 | 26 | ✓ | ✓ | | | | | | | | | | | | | | | | 4,90 € |
| N | 160.0493 | 145 | 108 | 24 | ✓ | | ✓ | | | | | | | | | | | | | | | 7,90 € |
| O | 160.0494 | 145 | 135 | 26 | ✓ | | | | | | | | | | | | | | | | | 6,90 € |
| P | 160.0495 | 160 | 135 | 28 | | | ✓ | | | | | | | | | | | | | | | 6,90 € |
| Q | 160.0496 | 140 | 103 | 25 | | | | | | ✓ | | | | | | | | | | | | 7,90 € |
| R | 160.0497 | 150 | 127 | 25 | ✓ | | | | | | | | | | | | | | | | | 5,90 € |
| S | 160.0498 | 140 | 132 | 28 | | | | | | | | | | | | | | | | | | 8,90 € |

i **1**
Weitere Informationen

7,90

800.0156 Kunststoff-Magnet-Schale, Ø 150 mm

i **1**
Weitere Informationen

9,90

150.2032 Metall-Reifen-Ventilhebel, 330 mm

i **1**
Weitere Informationen

27,90

911.8135 Runflat Reifen- und Montagehebel

i **1**
Weitere Informationen

49,90

800.0190 Metall-Magnethalter, 390 mm

i **1**
Weitere Informationen

19,90

515.1950 Druckluft-Reifenfüllmesser

600 mm

0 - 12 bar

1/4" PT

i **1**
Weitere Informationen

GEEICHT

61,90

515.1960 Geeichter Druckluft-Reifenfüllmesser

400 mm

0 - 10 bar

1/4" PT

i **5**
Weitere Informationen

56,90

150.1070 Reifenvulkanisier-Satz für KFZ, inklusive 100 mm Fäden

70 g

9 mm

60 x 100 mm

OPTIONAL ZUM NACHKAUF

60 Stück

17,90

150.1072

i **1**
Weitere Informationen

89,90

Aluminium-Radnabenschleifer-Satz Ø 150 mm, Innen-Ø 90 mm

100.5080

OPTIONAL ZUM NACHKAUF

34,90

100.5077

90 mm

150 mm

VORHER:

NACHHER:

i **4**
Weitere Informationen

8 mm

10 mm

9 mm

8 mm

NEU

OZ Spezial-Alu-Felgen-Stecknuss-Satz für mehrteilige OZ-Felgen

14,90

515.0795

i **3**
Weitere Informationen

39,90

1/2" Spiral-Profil-Kraft-Stecknuss-Satz, 3-tlg, 17-21 mm

913.1270 17 - 19 - 21 mm

i **2**
Weitere Informationen

19,5 mm

18,5 mm

19,5

21,5

20,5

20,5 mm

+

Spezial-Alu-Felgen-Kraft-Stecknuss-Satz für Ford, 18,5 / 19,5 / 20,5 / 21,5 mm

27,90

515.0895 18,5 - 19,5 - 20,5 - 21,5 mm

i **1**
Weitere Informationen

FÜR MERCEDES

max. 75 Nm

17,90

1/2" Kraft-Torsions-Verlängerung, 75 Nm

515.1491



Weitere Informationen



Radsicherungs-Demontageset



59,90

913.1480 18 - 19 - 20 - 21 - 22 - 23 - 24 - 25 mm



Weitere Informationen

Felgenschloss-Demontage-Satz



139,90



UNIVERSAL GENIAL - DIE PASSEN SICH AN JEDES PROFIL AN!

913.1430

ROBUSTE 1/2" ALU-FELGEN KRAFT-STECKNUSS-SÄTZE

1

Weitere Informationen

21 mm 19 mm 17 mm

17,90

515.1070 1/2" 17 - 19 - 21 mm

2

Weitere Informationen

15 mm 17 mm 19 mm 21 mm 22 mm

24,90

515.0870 1/2" 15 - 17 - 19 - 21 - 22 mm

3

Weitere Informationen

17 mm 15 mm 19 mm 22 mm 23 mm 21 mm 17 mm 21 mm 24 mm

69,90

515.0890 1/2" 15 - 17 - 19 - 21 - 22 - 23 - 24 mm 7/8" 17 mm MS21

4

Weitere Informationen

15 mm 17 mm 19 mm 21 mm 22 mm 23 mm 24 mm 17 mm 21 mm

139,90

DER KOMPLETTE ALLESKÖNNER

515.0885 1/2" 15 - 17 - 19 - 21 - 22 - 23 - 24 mm 7/8" 17 mm MS21 17 - 19 - 21 mm 18,5 / 19,5 - 20,5 / 21,5 - 17,5 / 22,5 mm

| | 515.1072 15 mm | 515.1073 17 mm | 515.1075 19 mm | 515.1076 21 mm | 515.1077 22 mm | 515.1078 23 mm | 515.1079 24 mm | 515.1089 Tesla 7/8" | 515.2055 Mercedes 17 mm | 515.2060 Hyundai KIA MS21 | 913.1271 Spiralstecknuss 17 mm | 913.1272 Spiralstecknuss 19 mm | 913.1273 Spiralstecknuss 21 mm | 515.0896 Ford 18,5 / 19,5 mm | 515.0897 Ford 20,5 / 21,5 mm | 515.0899 Ford 17,5 / 22,5 mm | 515.1134 Kraft-Verlängerung, 75mm |
|----------|-------------------|-------------------|-------------------|-------------------|-------------------|-------------------|-------------------|------------------------|----------------------------|------------------------------|-----------------------------------|-----------------------------------|-----------------------------------|---------------------------------|---------------------------------|---------------------------------|--------------------------------------|
| 1 | X | ✓ | ✓ | ✓ | X | X | X | X | X | X | X | X | X | X | X | X | X |
| 2 | ✓ | ✓ | ✓ | ✓ | ✓ | X | X | X | X | X | X | X | X | X | X | X | X |
| 3 | ✓ | ✓ | ✓ | ✓ | ✓ | ✓ | ✓ | ✓ | ✓ | ✓ | X | X | X | X | X | X | X |
| 4 | ✓ | ✓ | ✓ | ✓ | ✓ | ✓ | ✓ | ✓ | ✓ | ✓ | ✓ | ✓ | ✓ | ✓ | ✓ | ✓ | ✓ |

i 1
Weitere Informationen

aufladbar mit USB-C-Kabel (inklusive)

16,90

350 Lumen

UV LED

POWER-AREA Li-Ion 800mAh

mit Laserpointer

LED COB Stripe Inspektionslampe
350 Lumen mit UV-Spot LED und Laserpointer

150.4400

max. 3 h 3 h IP20

i 1
Weitere Informationen

140 mm

85 Lumen

2 x AAA

14,90

perfectLight
Taschenlampe 85 Lumen

25 m

150.4370

25 m max. 10 h IPX3

i 1
Weitere Informationen

MAX. 350 Lumen

MAX. 100 Lumen

270°

DAS MUST HAVE!
FÜR WERKSTATT ODER OUTDOOR

14,90

150.4520

USB-C On/Off
Sensorschalter
Li-Ion 3,7 V 1200 mAh
Power Display
Bewegungssensor
XPE LED 2 Leuchtstufen
Größeneinstellung
COB LED 3 Leuchtstufen

max. 8 h 4,5 h 95 g

| Modi | COB 100% | COB 40% | COB rot | XPE 100% | XPE 40% |
|-----------|---------------------|---------|---------|---------------------------|---------|
| LED | 270° 3 Watt COB LED | | | 1 Watt High Power XPE LED | |
| 40% 100% | 350 LM | 150 LM | - | 100 LM | 40 LM |
| | 3 h | 6 h | 8 h | 4 h | 8 h |

On/Off

17,90

Weitere Informationen

360°

250 Lumen

500 Lumen

USB

ON OFF

1200 mAh Lithium-Ionen Akku (inklusive)

180°

oder

3x AAA Batterien (nicht im Lieferumfang enthalten)

inklusive USB Power Bank Funktion

| | |
|-------|-------|
| 20 % | ● |
| 40 % | ●● |
| 60 % | ●●● |
| 80 % | ●●●● |
| 100 % | ●●●●● |

150.4510

max. 3 h

3 h

IP65

19,90

Weitere Informationen

130 Lumen

300 Lumen

ON OFF

USB-A OUT

USB-C IN

integrierter Lithium-Ionen Akku 1.200 mAh

| | |
|-------|-------|
| 20 % | ● |
| 40 % | ●● |
| 60 % | ●●● |
| 80 % | ●●●● |
| 100 % | ●●●●● |

150.4505

max. 3 h

3 h

IP65

16,50

Weitere Informationen

60 Lumen

150 Lumen

360°

Micro USB

ON OFF

| | |
|-------|-------|
| 20 % | ● |
| 40 % | ●● |
| 60 % | ●●● |
| 80 % | ●●●● |
| 100 % | ●●●●● |

150.4495

max. 3,5 h

2,5 h

IP20

37,50

Weitere Informationen

250 Lumen

550 Lumen

ON OFF

USB-A OUT

USB-C IN

| | |
|-------|-------|
| 20 % | ● |
| 40 % | ●● |
| 60 % | ●●● |
| 80 % | ●●●● |
| 100 % | ●●●●● |

150.4490

max. 3,5 h

3 h

IP65

i  **11**
 Weitere Informationen



20-200 Nm

mit Kalibrier-
Konformitätserklärung
DIN EN ISO 6789
Zertifikat
 Konformität #123

KALIBRIER-KONFORMITÄTserklärung
 Konformitätserklärung nach DIN EN ISO 6789:2013

125 mm

10 mm 13 mm 17 mm 19 mm 21 mm 24 mm

17 mm 19 mm 21 mm

1/2" 500 mm

119,90

516.2400 1/2" 10 - 13 - 17 - 19 - 21 - 24 mm

i  **8**
 Weitere Informationen

**FÜR REIFENWECHSEL
 IN REKORDZEIT**

21 mm 19 mm 17 mm

1/2"

1600 Nm

2 x Ø 150 mm

0 - 12 bar

10 m

NEU

119,90

Ihr Partner:

 LL23-06D_EUR

KS Tools Werkzeuge - Maschinen GmbH
 Seligenstädter Grund 10 - 12
 D-63150 Heusenstamm
 DEUTSCHLAND

Mail: aftersales@kstools.com
 Web: www.kstools.com

515.2100

Mit Erscheinen dieses Prospektes verlieren alle vorangegangenen Preise hiermit ihre Gültigkeit. Verkauf nur an den Fachhandel. Druckfehler, Irrtümer und technische Änderungen vorbehalten. Alle Preise in EUR zzgl. MwSt. gelten bis 30.09.2024.